

Mⁱ™
INC.
MUTUAL
INDUSTRIES



**You've Found
America's Premier
Manufacturer of
Construction and
Safety Accessories**

mutualindustries.com



QUALITY MANUFACTURING FOR OVER A CENTURY

Mutual Industries Inc... A Manufacturing Leader Since 1910

Mutual Industries, Inc. has been an industry leader in developing and manufacturing a diverse line of quality products for over 100 years.

Mutual's line of quality construction, safety, and surveying materials continues the quality tradition. Mutual's flagging/surveying tapes, barricade tapes, flags, safety fence and silt fence have set the industry standard.

Growth with New Brands and Companies

Over the years, Mutual has also become the premier manufacturer of sediment control and erosion control products as well. This has been further enhanced by the recent addition of EcoDepot and its erosion products.

With the creation of the MiViz Brand, Mutual has further expanded its full line of safety vests and personal protection apparel. Gann Manufacturing, another Mutual company, manufactures custom "Made in USA" safety vests and apparel, as well as the Kromer brand of headwear (popular throughout the world). MiViz and Gann combine to uniquely position Mutual as the manufacturer that can provide the most comprehensive safety apparel offerings in the industry.

The addition of GBM and its building materials, augments Mutual's existing construction accessory offerings to offer a complete solution for many construction needs.

Most notably, the recent acquisition of Harris Industries has enhanced Mutual's product line of high quality custom printed barricade tapes, underground tapes, pipe and electrical markers and many other safety identification products. In addition, Mutual now has more manufacturing capabilities with its 2 new plants: one in Huntington Beach, CA; and the other in Pawtucket, RI. These bi-coastal locations allow Mutual to provide even more responsive on-time service, as well as cost savings on freight.



SILTCO INDUSTRIES



The Mutual Advantage

With its increased Made in USA capabilities, Mutual's products are manufactured to the same exacting standards and level of quality that you've come to expect, while being very competitively priced.

Mutual Industries' rigid quality control procedures developed over a century ago, guarantee that the products designed and manufactured today can withstand a wide variety of hostile environmental conditions without field failure.

Look no further when choosing a manufacturer. With such a vast array of quality construction, safety, surveying, geotextile and erosion control products ready to ship, Mutual Industries is definitely.....

"Your One Great American Source"

MTMINC.
MUTUAL
INDUSTRIES

Manufacturing
Excellence
Since 1910





6 SILT FENCE PRODUCTS



10 EROSION CONTROL



16 SANDBAGS

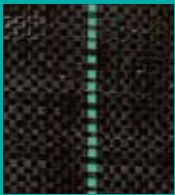

18 GEOTEXTILE PRODUCTS

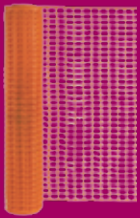

20 SAFETY FENCES



24 BARRICADE TAPES



28 NON-ADHESIVE TAPES



30 REFLECTIVE TAPES



32 SPECIALIZED TAPES

TABLE OF CONTENTS

SILT FENCES 6
Prefabricated • Wire Backed • Super Silt • Silt Fabrics

EROSION CONTROL PRODUCTS 10
Straw Wattles • Blankets • Jute • Turbidity Barriers • Tree Bags • Ground Cover • Filter Bags • Inlet Covers • Gabions • TreeMatts™ • BioBark™ • Coir Mat • Coir Logs

SAND BAGS 16
Bulk Bag • Woven Contractor Bag • Woven Polypropylene Self Inflating • Burlap • Chair Bag

GEOTEXTILE PRODUCTS 18
Non-Woven • Woven

SAFETY FENCES 20
Warning Barrier • Diamond Link • Snow/Sand • Privacy

BARRICADE TAPE PRODUCTS 24
Caution Tape • Reinforced • Repulpable • Biodegradable

SPECIALIZED TAPE PRODUCTS – NON-ADHESIVE .. 28
Detectable • Non-Detectable • Woven Barricade Webbing

REFLECTIVE TAPE PRODUCTS – ADHESIVE 30
Vehicle Conspicuity • Pavement Marking • Hazard Stripe Barricade

SPECIALIZED TAPE PRODUCTS & SIGNS..... 32
Hazard Stripe • Anti-Skid • Duct • Electrical • Labels • Pipe Markers • Carton Sealing • Homeland Security • Signs

FLAGGING TAPE 42
Surveying • Biodegradable • Aerial Targets
Printed Flagging Tape

MARKING & MEASURING PRODUCTS44
Stake Whiskers • Marking Flags • Paint • Marking Machines

PENNANTS & MARKERS 48
Pennant Flags • OSHA Perimeter Markers • Poly-Safety Rope
OSHA Perimeter Marker Stanchions

REBAR CAPS AND FALL PROTECTION.....50
 OSHA Rebar Caps • Tent Caps • Safety Harness/Lanyard

SAFETY VESTS AND ANSI APPAREL 52
 Premium Class 2 ANSI Vests - Zipper.....52
 Premium Class 3 ANSI Vests - Zipper.....54
 High Value ANSI Vests - Zipper55
 Premium ANSI Vests - Hook & Loop.....56
 ANSI Class E Pants.....58
 ANSI T-Shirts59
 GANN Flame Resistant - Vests & T-Shirts61
 GANN Made in USA - ANSI Vests.....62
 GANN Custom Made in USA - Vests63
 Basic Vests - Non ANSI.....65
 ANSI Outerwear & Rainwear69
 High Visibility Accessories.....70

TOOLS.....71
 Shovels • Pallet Jacks • Hand Trucks

TRAFFIC SAFETY PRODUCTS.....72
 Traffic Cones • Barricades • Light Batons • Flags
 Stop/Slow Paddles

PERSONAL PROTECTION PRODUCTS 80
 Hard Hats80
 Hard Hat Accessories81
 Winter Liners82
 Kromer Caps88
 Beanies & Welding Safety Accessories90
 Headwear91
 Rainwear and Boots92
 Eyewear and Safety Glasses94
 First Aid Kits and Dust Masks.....96
 Hearing Protection, Coveralls, and Maintenance98
 Gloves and Knee Pads100
 Neoprene Supports 101

BUILDING MATERIALS 102
 Fiber Forms • Blast Sand • Backer Rods • Anchor Bolts
 Wall Ties • Nail Stakes • Wall Trusses • Rod Chairs
 Concrete Columns • Windows • Lath • Drainage Products
 Fireplaces and Accessories

42 FLAGGING TAPES 

44 MARKING & MEASURING 

48 PENNANTS & MARKERS 

50 REBAR CAPS 

52 SAFETY VESTS 

71 TOOLS 

72 TRAFFIC SAFETY 

80 PERSONAL PROTECTION 

102 BUILDING MATERIALS 

SILT FENCES

SILT FENCE PRODUCTS



CONTRACTORS GRADE SILT FENCE Part# 14987

Nearly 70% of all construction jobs that require silt fence do not specify the type of fence that must be used. Save money by using Mutual's superior quality non-spec contractors grade silt fence:

- Economical 36" or 24" width silt fabrics
- 1½" x 1½" (Nominal) hardwood stakes
- Stakes spaced every 10' (10' centers)
- 11 stakes per 100' fabric

If you're stocking a fence with specs other than these for non-spec jobs, you're probably paying too much!



SILT FENCE WITH LATH Part# 14987

Mutual's wood lath silt fence is manufactured to stop the fabric from tearing away from the posts in the field. The lath is stapled thru the fabric and into the post.



FABRIC

Economical: 24", 36"
High Spec: 24", 30",
36", 42", 48", 50"

STAKES

Hardwood
1½" x 1½" (Nominal)
2" x 2" (Nominal)
36", 48", 54" Length

STAKE SPACING

10' Centers 6' Centers
8' Centers 5' Centers
7' Centers 4' Centers

PROPER INSTALLATION

Dig a 6" deep trench to prevent sediment flow underneath the fence. Unroll fence and drive stakes in center of trench to bottom of fabric. Make sure all stakes are on the down slope side of fence.

**Custom
printing
available.
Call for
details.**



EASY SILT FENCE INSTALLATION TIP

Silt fence is more durable and resistant to wind damage if each post is twisted 180° during installation. This wraps each post with silt fence fabric on both sides, reducing the likelihood of the fabric tearing away from the post in a high wind situation.



WIRE BACK

WIRE BACK AND SUPER SILT FENCES



WIRE BACK SILT FENCE

Part# 1776-14 Black

Part# 1776-45 Orange

MISF 1776 Fabric with
14GA Wire Mesh

Available in:

- 36" High Black Fabric with 24" Wire Mesh
- 36" High Black Fabric with 36" Wire Mesh
- 48" High Black Fabric with 36" Wire Mesh
- 48" High Orange Fabric with 36" Wire Mesh



SUPER SILT FENCE KITS

Part# 14987-180-50

The kit consists of chain link (6 ga, 9 ga, or 11½ ga), a roll of 901 fabric, posts (SS20, or SS40 post), aluminum pre ties, and hog rings.



SUPER SILT FENCE PLIERS

Part# 99-1

Used with hog rings, these quality pliers fasten chain link to the silt fence of super silt fence.

TO ORDER, CALL TOLL FREE: (800) 523-0888 or (215) 927-6000



MISF 3014 POLY MESH BACKING **Part# 3014**

Mutual's oriented polypropylene mesh is ideal for use on supported silt fence requirements. This incredibly strong yet flexible material is an accepted alternative by many state DOT in place of 14 or 12½" gauge wire backing. Available in 30" x 500' or 30" x 5000' rolls.



PRE-POCKETED SILT FENCE **Part# 14987**

Mutual's pre-pocketed silt fence is Mutual's 36" high with pockets sewn 6 feet on center. It is available as prefabricated fence with stakes attached in 100 feet long rolls or without stakes attached in bulk 500 foot rolls.



NOMINAL HARDWOOD STAKES **Part# 14650** 1½" **Part# 14651** 2" **Part# 14666** Fence Posts 1"x 2"x 60"

High grade hardwood stakes have pencil points for easy driving. Use to assemble your own silt fence, staking hay bales, perimeter markers, etc.

Available in the following stock sizes:

- 1½" x 1½" Nominal 48", 36"
- 2" x 2" Nominal 48", 42", 36", 60"
- 1" x 2" Nominal 60"
- 2" x 2" x 72' Nominal Tree Stakes



STEEL T-POST **Part# 14646**

Mutual offers 4' T-post unpainted with no kick plate and 5' or 6' painted T-post with no kick plate for most wire back silt fence applications. 200 per bundle.



CHANNEL POST **Part# 14645**

Mutual's heavy duty steel posts are easy to install and are made of durable 13 gauge steel. They are rust proofed by phosphate etching and feature a green enamel finish. Each post has a stabilizing anchor plate, and comes in 5' and 6' heights. 150 per bundle.



POST POUNDER **Part# 14646-0**

Make installations easy with Mutual's Post Pounder, featuring a solid steel head for maximum driving force. The side handles on this steel post pounder are tapered outward and back for a more comfortable grip and to keep your hands out of the way if driving posts close to fence lines. Steel post pounder drives posts up to 2½" in diameter. 24" long and weighs 23 lbs.

SILT FENCE FABRIC



MUTUAL WOVEN SPECIFICATIONS		MISF 150	MISF 180	MISF 1855	MISF 901	MISF 1776	WF200	MISF1845
Grab Tensile Strength	ASTM D-4632	90 lbs.	110 lbs.	120 lbs.	134 lbs	144 lbs	205 lbs	134 lbs
Grab Elongation	ASTM D-4632	15%	15%	15%	15%	15%	19%	15%
Trapezoid Tear	ASTM D-4533	55 lbs.	60 lbs.	80 lbs.	60 lbs	65 lbs	100 lbs	60 lbs
Puncture	ASTM D-6241	60 lbs.	60 lbs.	60 lbs	60 lbs	75 lbs	110 lbs	60 lbs
Permittivity	ASTM D-4491	0.1 SEC	0.13 SEC	0.3 SEC	0.12 SEC	0.2 SEC	0.08 SEC	0.12 SEC
A.O.S.	ASTM D-4751	50 US Sieve	40 US Sieve	50 US Sieve	30 US Sieve	35 US Sieve	40 US Sieve	30 US Sieve
U.V. Resistance (500 hr)	ASTM D-4355	80%	80%	80%	80%	80%	90%	80%

TO ORDER, CALL TOLL FREE: (800) 523-0888 or (215) 927-6000

EROSION CONTROL PRODUCTS

EROSION CONTROL PRODUCTS



QUICKGRASS

Part# 17687-MEBQ

4' x 112½'

Single Net blanket dyed green.



STRAW BLANKET

Part# 17681-MSB1

Part# 17681-MSB2

8' x 112½' (Total: 100 sq yds)

Single Net – 100% weed free AG straw for use on slopes up to 3:1 and low flow channels.

Double Net – 100% weed free AG straw for use on slopes up to 2:1 and moderate flow on channels.



COCONUT BLANKET

Part# 17683-MCB2

8' x 112½'

(Total: 100 sq yds) 100% coconut fibers used on slopes 1:1 or greater and in channels with heavy flows.



EXCELSIOR BLANKET

Part# 17687-MEB1

Part# 17687-MEB2

4' x 112½' (Total: 50 sq yds)

8' x 112½' (Total: 100 sq yds)

Single Net – 100% Rocky Mtn Aspen used for slopes 2:1 or less and areas of light to moderate rainfall & runoff.

Double Net – 100% Rocky Mtn Aspen used on slopes up to 1:1 and areas of moderate to heavy rainfall.



STRAW WATTLE

Part# 17669

Straw Wattles are tubular products consisting of the finest available agricultural straw fibers encased in durable netting. The straw fibers are certified weed seed free. Straw wattles may be placed across channels bottoms, but their primary use is on hillslopes to break up slope lengths and slow overland flow. Available in 9" x 25' or 12" x 10'.



PERMANENT BLANKET

Part# 17694-MPB

8' x 90' (Total: 80 sq yds)

100% synthetic fibers for use in large flow channels and severe slopes.

BLANKETS



STRAW COCONUT BLANKET Part# 17684-MSCB2

8' x 112½' (Total: 100 sq yds) 70% Weed free AG straw – 30% coconut fibers used on slopes up to 1:1 and in channels with moderate flows.



JUTE Part# 17685-MJB

4' x 225' (Total: 100 sq yds)
100% woven coir used on slopes up to 2:1 with light to moderate runoff.



BURLAP FABRIC Part# 44004

Mutual's 7 oz. burlap fabric is so versatile and is available in untreated rolls of 48" x 100 yd.



SOD STAPLES Part# 17686

Ideal for keeping blankets in place, these metal staples are available in:

- 8 gauge 8" – 250/Box
- 8 gauge 12" – 250/Box
- 11 gauge 4" – 1,000/Box
- 11 gauge 6" – 1,000/Box



FABRIC PINS Part# 17686

Ideal for fastening landscape fabric and ground cover. Available in 12" and 18" lengths, 100 per box.



STAPLE SETTER Part# 17686-11-42

Staple setter means no bending down, making securing erosion control blankets, landscape fabrics, and geotextile fabrics easy. 42" handle with magnetic grip pushes staples all the way into the ground.

EROSION CONTROL PRODUCTS

EROSION CONTROL PRODUCTS



TURBIDITY BARRIER

Part# 3200-4-60 Contractor **Part# 3200-6-60** Type I
Part# 3200-8-60 Type II

Mutual's Floating Turbidity Barrier provides a restricted flow of silt laden runoff from construction sites. Turbidity barriers are highly effective in allowing silt and sediment to settle out before being carried into adjacent or adjoining waterways. Available in 50' lengths.

SPUNBOUND FABRIC

Part# 32

Mutual's Landscape fabric is a safe and effective way to stop weeds. This professional grade, spunbound material has a high strength to weight ratio, and maintains soil moisture as well. Available in convenient 3', 4', 6' and 12' widths in 300' lengths for easy installation.



ULTRA GROUND COVER

Part# 21

Mutual's new Ultra Ground Cover is a unique geotextile material made of woven polypropylene fabric on one side, and non-woven on the other side, mated together with evenly spaced lines for easy plant alignment.

Features/Benefits

- Strength of a woven
- Permittivity of a non-woven
- Planting stripes make spacing quick and easy
- Ideal for weed control
- Retains moisture for plant health
- Perfect for soil/landscape stabilization

Available in the following size rolls:
3' x 250', 3' x 100', 4' x 250', 4' x 100', 6' x 250', 6' x 100'

STAKED TURBIDITY BARRIER

Part# 3100-44 44" x 100' Material Only
Part# 3100-6-44 44"x 50' With Stakes

Staked barriers are continuous panels of impervious vinyl-polyester fabric that, installed correctly, can contain storm water runoff or re-direct it to proper channels or retention areas. On-land installation is similar to that of silt fence, with 8 inches below grade and 36 inches above grade attached to stakes. Staked Barriers can also be installed in up to 18 inches of water. The barriers are sold as fabric only 44" x 50' or with stakes attached every 6' apart.

TREE WATERING BAG

Part# 14700

Mutual's tree watering bag is used to water young trees or useful when planting a new tree. The bag distributes roughly 20 gallons of water around the base of a tree in 5-7 hour period. The bag fits up to a 4" diameter tree. The bags can easily be filled with a standard garden hose or a hose up to 3" in diameter.

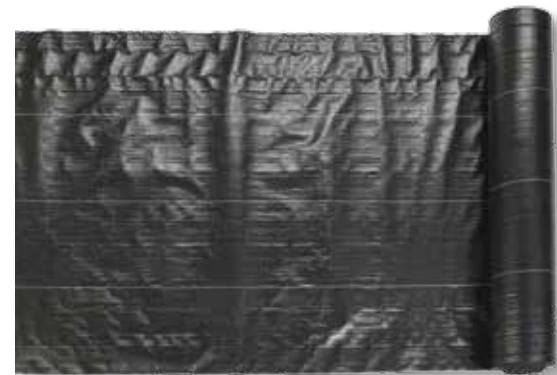

GC125 GROUND COVER

Part# 25

Mutual's 125 weight ground cover has convenient planting guide lines placed every 12 inches for even rows. Available: 3' x 300', 4' x 300', 6' x 300', 12' x 300' rolls.

TREEMATS



TREEMATS™

Part# 8825

The perfect alternative to hardwood mulch. They are easy to install and will last for two growing seasons. Tree mats eliminate the use of harmful herbicides and other chemicals. They hold nine times their weight in water. This means less watering and better survival rates for trees and shrubs. Available in 12", 16" and 30" sizes. 100/ Pack

- Provides superb moisture retention
- Installs in seconds
- 100% Biodegradable coconut fiber
- Ideal for slope planting
- Tree mats are aesthetically pleasing
- Eliminates the need for mulch bags
- You can carry enough tree mats in a wheelbarrow to protect over 100 trees!



BIOBARK™

Part# 8800

- Designed for Deer Control
- Provides Tree Protection
- All-in-One Unit
- Installs in Seconds
- Cost Effective
- 100% Biodegradable
- ¼" Hardwood Slats Bound with Rope
- 4 AnchorStakes
- Aesthetically Pleasing
- Open-air design = no nesting birds



400

700

900

COIR MATTING

Part# 17685

100% biodegradable geotextile fabric used for slope stabilization. Prepare slope, apply seed and install matting. Seeds grow through the fabric. Will fully degrade over 3-5 years. Available in 6.6' x 164' and 120 sq yards



COIR LOG

Part# 17687

The only Coir Log that has pre-drilled holes for stakes or plants. 100% biodegradable logs are used at the toe of slopes and ponds to create a natural protection system when plants root in and around the log. Eliminates the need for two rows of wooden stakes and Coir twine. Available in 12' x 10', 16' x 10', 20' x 10' and 24' x 10'.

EROSION CONTROL PRODUCTS

EROSION CONTROL PRODUCTS



SEDIMENT FILTER BAG

Part# 15925

10 oz non woven geotextile bag used to filter sediment from pumped discharged water.

Sizes available: 5' x 6', 7½' x 7½', 7½' x 15', 15' x 15', and 15' x 30'.



ULTRA PIPE SOCK

Part# 14929

Mutual's Ultra-Silt Sock is perfect for controlling erosion and filtering contaminants from a water source. This durable geotextile filter media is formed like a sock to allow large volumes of water to pass through while absorbing sediment, and contaminants including liquid hydrocarbons, petroleum, animal or vegetable oils.

- Sock is 60" long, fits 8" opening size
- Great for preventing sediment in-flow during high water events.
- Draw string cord allows for convenient fastening to pipes.



TREE SIGNS

Part# 44

Mutual's Tree Signs are made of high quality PVC with fade resistant printing. Signs are available for the following applications: Reforestation Project, Forest Retention, Specimen Tree, and Wetland Protection.

GABIONS



GALVANIZED PVC COATED GABION BASKETS **Part# 99-3**

Mutual's high quality gabion baskets are ideal for retaining walls, or along stream beds to help with restoration. Available in the following sizes: 3'x 3'x 1', 3'x 3'x 3', 3'x 6'x 1', 3'x 3'x 6', 9'x 3'x 1', 9'x 3'x 3', 12'x 3'x 1', and 12'x 3'x 3'. Other sizes are also available upon request.

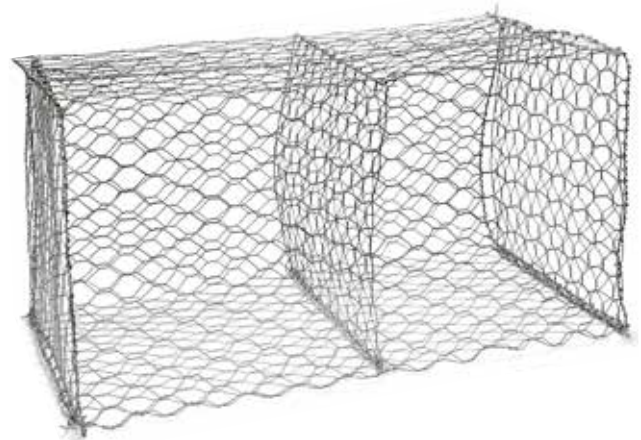

SUPER SILT FENCE PLIERS **Part# 99-1**

Used with hog rings, these quality pliers fasten chain link to the silt fence of super silt fence.



INLET COVER **Part# 17682**

This 2' x 4' inlet cover reduces the amount of silt and debris that may enter a storm water inlet during construction.



SILT SACKS **Part# 14925**

Used for reducing the amount of silt and debris that may enter a storm water inlet during construction, these 4' x 2' x 3' sacks are placed inside the storm drain to collect debris as it enters the opening.



SAND BAGS

SAND BAG PRODUCTS

FIBC BULK BAG

Part# 14981-0-3

This 3' x 3' x 3' flexible intermediate bulk container is capable of holding over 3000 lbs of material. Often filled with sand and used as a water barrier in streams or rivers. Unfilled Dimension of 35"x 35"x 40" • 4.4 oz/sq. yd. Uncoated UV Treated Woven • Polypropylene • Solid Flat Bottom • (4) 10" Long 5000lb strength lifting loops • Safe Work Load of 2500 lbs at 5:1 safety factor

WOVEN CONTRACTOR BAGS

Part# 14981-10-110

Super tough • 110lb. capacity
• Heavy Tear Resistant Polypropylene
• 20 Bags per box • 42 Gals
• Reusable • 30" x 52" • 75cm x 132cm



SELF INFLATING JUTE SAND BAG

Part# 14981-24-14

This bag automatically absorbs water and expands in contact with water. By taking advantage of their properties of automatic expansion due to the super water absorbent materials, people can fight water with water and control flooding with the fastest speed in emergency. It saves time and manpower effectively. Inflates to 40-44 lbs in 3-5 minutes.



SAND BAGS



10 OZ BURLAP SAND BAGS

Part# 14974-0-14

Mutual's heavy 10 oz burlap sand bags are great for flood barriers, military uses, and rip rap. Each bag is 14" x 26" with a tie-string that pulls the top closed. Available in bails of 1000 only.



SAND BAGS (WOVEN POLYPROPYLENE)

Part# 14981-10 White

Part# 14981-45 Orange

Mutual's "circular woven" poly-propylene sandbags come complete with heavy poly-twine ties. Available in white and bright orange (1600 hr. UV protection) for increased visibility. The sandbags come in 2 sizes: 14"x 26" weighing 50 lbs. when filled, and 18"x 27" weighing 75 lbs. when filled.



GREEN SAND BAGS

Part# 14981-39-14

This green 850 denier polypropylene sandbag is constructed with a 10 x 10 weave per square inch, is heat top cut, and offers 1600 hour UV protection. Sold in bales of 1000.



BLACK SAND BAGS

Part# 14981-91-14

Mutual's EXTRA heavy duty black sandbags are produced to hold down road sign bases, and also functions as road traffic equipment stabilizers. • Black doublestrength 14' x 26" sandbags; mesh 12" x 12"; weight 56 grams per piece • Top hemmed and single folded. Double stitched bottom • UV 1600 hours plus, with tie strings. Sold in bales of 1000.



CHAIRBAGS

Part# 14971-10-2240

Another Mutual exclusive! Chair bags protect expensive lacquered folding chairs from nicks, abrasions, and chips while in storage. Made from a tough 900-denier circular woven 22" x 40" polypropylene, these chair bags are made to fit over each chair and then be placed into their cloth carry bag. Mutual chair bags keep your chairs looking like new longer. 100 per bale.

GEOTEXTILE PRODUCTS

NON WOVEN



MUTUAL NON-WOVENS

Mutual's non-wovens are available in cut rolls. NW35 is in stock in the following sizes: 9' x 300', 7½' x 300', 6' x 300', 4' x 300', 3' x 300', 2' x 300', and 1' x 300'. All other non-wovens available in 12½' x 360', and 15' x 300'.

MUTUAL NON-WOVENS									
USES	NW35	NW40	NW45	NW60	NW80	NW100	NW120	NW160	
Subsurface Drainage	X	X	X	X	X				Non-woven geotextiles used as a filter, allow subsurface water to pass into drainage core while preventing soil from clogging the system
Drainage Systems			X	X	X	X			When placed in contact with a Geonet or drainage stone non-woven geotextiles can filter soil and waste while allowing water and waste to pass
Liner Protection					X	X	X	X	Non-woven geotextiles protect liners from damage by sharp objects, elevating puncture impact and abrasion resistance
Asphalt Overlay	X	X	X	X					Absorb asphalt tack to form moisture barrier that retards reflective cracking
Railroad Stabilization			X				X	X	Putting a non-woven geotextile directly on a soft saturated subgrade extends road and rail life by preventing aggregate and ballast from intermixing with soil
Erosion Control					X	X	X	X	Non-woven geotextiles can help relieve hydrostatic pressure beneath hard armor and prevent subsurface soils from migrating through the erosion control system
Roadway Stabilization		X			X	X			Putting a non-woven geotextile directly on a soft saturated subgrade extends road and rail life by preventing aggregate and ballast from intermixing with soil
Waste Management					X	X			Non-woven geotextiles are used to separate layers and to protect liners in the landfills

Mutual Non-Woven Specifications		NW35	NW40	NW45	NW60	NW80	NW100
Grab Tensile Strength	ASTM D-4632	90 lbs.	105 lbs.	120 lbs.	165 lbs	215 lbs	270 lbs
Grab Elongation	ASTM D-4632	50%	50%	50%	50%	50%	50%
Trapezoid Tear	ASTM D-4533	35 lbs.	45 lbs.	50 lbs.	90 lbs	85 lbs	100 lbs
Puncture	ASTM D-4833	55 lbs.	60 lbs.	65 lbs	90 lbs	115 lbs	150 lbs
Mullen Burst	ASTM D-3786	185 PSI	210 PSI	230 PSI	310 PSI	360 PSI	450 PSI
Permittivity	ASTM D-4491	2.2 SEC-1	2.2 SEC	1.5 SEC-1	1.1 SEC	1.0 SEC	.7 SEC
Permeability	ASTM D-4491	.2 CM/SEC	.2 CM/SEC	.25 CM/SEC	.2 CM/SEC	.25 CM/SEC	.25 CM/SEC
A.O.S.	ASTM D-4751	.21 US Sieve	70 US Sieve	70 US Sieve	80 US Sieve	80 US Sieve	100 US Sieve
Water Flow	ASTM D-4491	110 gpm/ft2	150 gpm/ft2	120 gpm/ft2	80 gpm/ft2	65 gpm/ft2	55 gpm/ft2
U.V. Resistance (500 hr)	ASTM D-4355	70%	70%	70%	70%	70%	70%
Weight (oz/sq yd)	ASTM D-5261	3.5 oz	4 oz	4.5 oz	6 oz	8 oz	10 oz

NONWOVEN



MUTUAL WOVENS

Mutual's wovens are available in cut rolls in the following sizes:

WF200: 12½' x 432', 15' x 360', 17½' x 309', 30" x 300', 36" x 300', 42" x 100', 42" x 300', 72" x 100' and 72" x 300'

WF315: 12½' x 360'

GC125: 3' x 300', 4' x 300', 6' x 300', 12' x 300'

MUTUAL WOVENS				
USES	GC125	WF200	WF315	
Ground Cover	X			Woven geotextiles are used to hold soil in place. They can also be used under Rip Rap, Gabions or precast block. Woven geotextiles are a time and money saving alternative to traditional methods using graded aggregate or sand filters.
Separation		X	X	To prolong surface life and stabilize the foundation.
Stabilization		X	X	Woven geotextiles provide a rugged separation layer between aggregate and subgrade.

TIRE SCRUB FABRIC (DRIVEWAY KIT)

Part# 200-125-54

The WF200 12½' x 54' (75 Sq. Yds.) fabric is placed under aggregate and stabilizes the ground to be used as a tire scrub for trucks entering or leaving a job site. The purpose of a stabilized entrance is to reduce or eliminate the tracking of sediment onto public right of ways and streets. Reducing tracking of sediments and pollutants onto paved roads help prevent deposition of sediments into local storm drains and production of airborne dust.



Mutual Woven Specifications		GC125 GROUND COVER	WF200 WOVEN GEOTEXTILE	WF315 WOVEN GEOTEXTILE
Grab Tensile Strength	ASTM D-4632	125 lbs.	200 lbs.	315 lbs.
Grab Elongation	ASTM D-4632	15%	15%	15%
Trapezoid Tear	ASTM D-4533	70 lbs.	75 lbs.	120 lbs.
Puncture	ASTM D-4833	68 lbs.	100 lbs.	120 lbs.
Mullen Burst	ASTM D-3786	291 PSI	400 PSI	600 PSI
Permittivity	ASTM D-4491	.07 SEC	.07 SEC	.05 SEC
Permeability	ASTM D-4491	—	.005 CM/SEC	.005 CM/SEC
A.O.S.	ASTM D-4751	40 US Sieve	40 US Sieve	40 US Sieve
Water Flow	ASTM D-4491	—	—	4.0 gpm/ft2
U.V. Resistance (500 hr)	ASTM D-4355	90%	90%	90%



FABRIC PINS

Part# 17686

Ideal for fastening landscape fabric and ground cover. Available in 12" and 18" lengths, 100 per box.

SAFETY FENCES

SAFETY FENCE PRODUCTS

MADE FROM
RECYCLED
MATERIALS

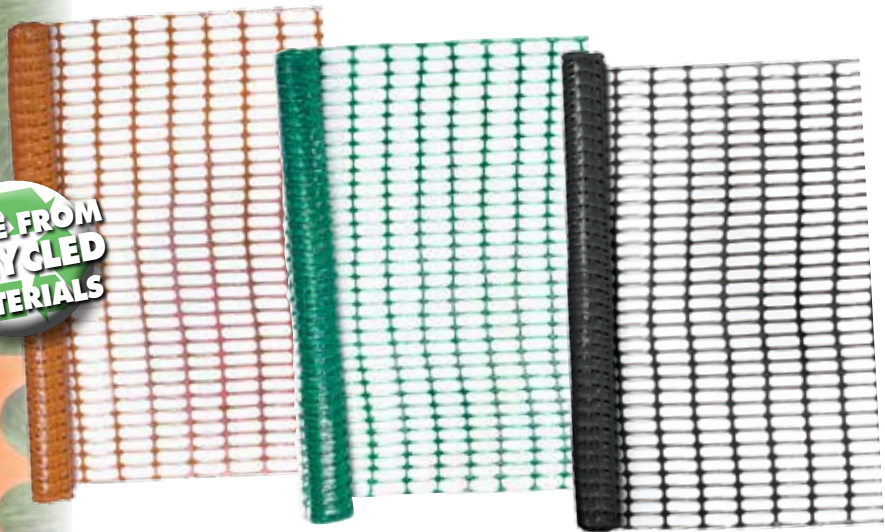

WARNING BARRIER FENCE

Part# 14993 ORANGE **Part# 14993-38** GREEN

Part# 14993-91 BLACK

Mutual's Warning Barrier fence is an extremely versatile and economical plastic construction site safety fence. In lightweight 4' x 100' rolls, 4' x 50' rolls, flexible warning barrier fence is easy to handle as well as install. This fence is highly visible and is ideal for all construction applications as well as Haz Mat, crowd control, and many other uses.

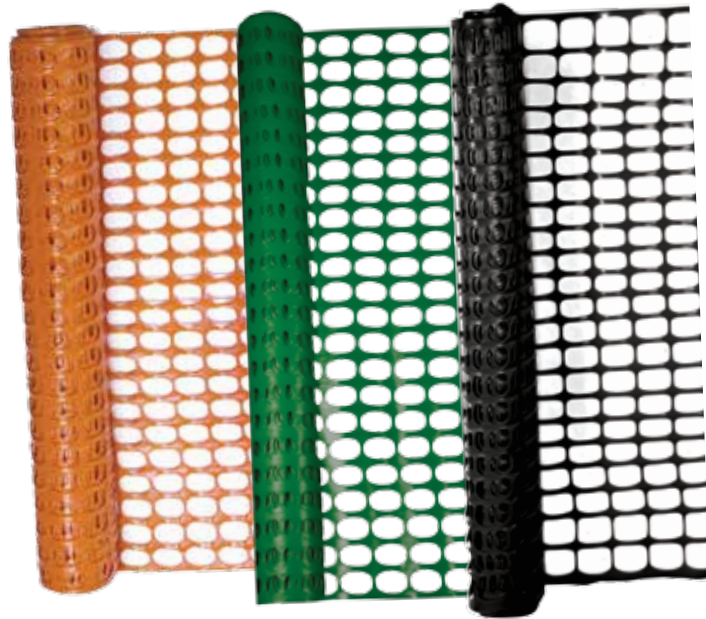

HEAVY-DUTY WARNING BARRIER FENCE/SNOW GUARD FENCE

Part# 14973 ORANGE **Part# 14973-38** GREEN

Part# 14973-91 BLACK

A heavier version of Mutual's 14993 Warning barrier. Ideal for temporary snow and sand control, or for any application where a more durable warning barrier fence is desired. 4' x 100' rolls and 4' x 50' rolls.

WARNING BARRIER



DIAMOND LINK FENCE

Part# 14988-45 ORANGE

Part# 14988-38 GREEN

Part# 14988-91 BLACK

These high density polyethylene (HDPE) fences are very rigid and very strong. They look and feel like chain link but are all plastic. Available in OSHA orange for traditional construction applications, as well as 4 other colors, they are used in sporting events, for crowd control, parades, golf tournaments and stadiums. Diamond link fence is available in 4' x 50' rolls.



BARRICADE SAFETY FABRIC

Part# 14997

BARRICADE SAFETY FENCE

Part# 14989 PRE-POSTED

Mutual's revolutionary woven polypropylene fabric fence is flexible and lightweight, yet very strong. Thirteen extruded solid bands make this fence highly visible and resilient. The lightweight fabric (only 14lbs. for a 4' x 150' roll) makes it easy to install even on irregularly contoured land or over existing obstacles. Available in high-visibility orange in 4' x 150' rolls without posts. Pre-posted fence is available in 4' x 100' rolls with eleven 1" x 2" x 5' posts pre-attached.

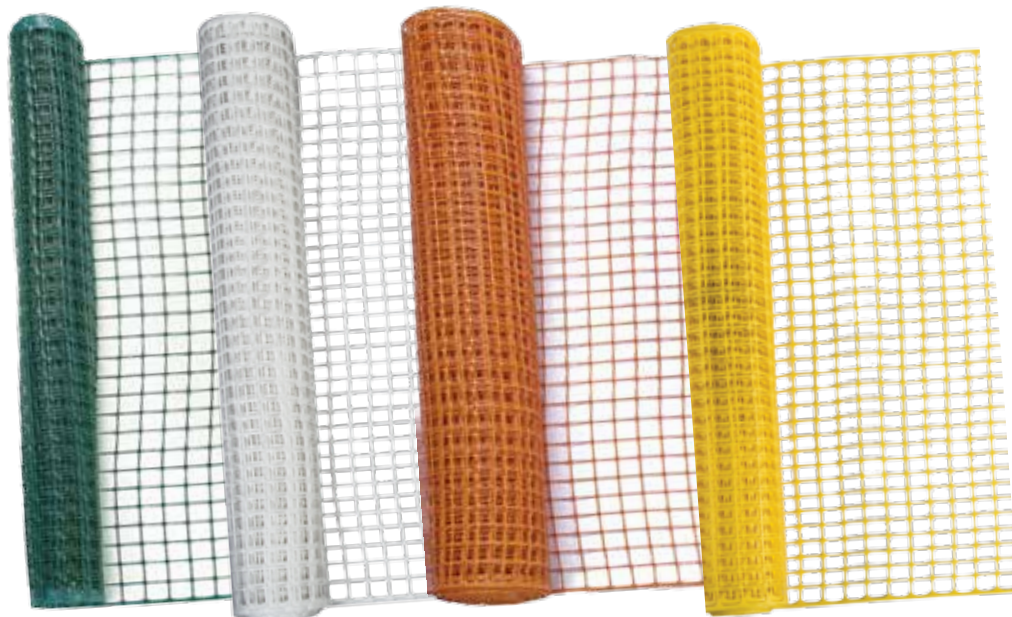

SAFE-T-EDGE FENCE

Part# 14900-38 GREEN

Part# 14900-10 WHITE

Part# 14900-45 ORANGE

Part# 14900-41 YELLOW

Part# 14900-91 BLACK

A variation of Diamond Link Fence, Mutual's Safety Edge fence features a no-snag smooth top. This HDPE fence is also very rigid and strong. It is available 4' x 100' in Orange and 4' x 50' in Orange, Green, White, Black and Yellow.

SAFETY FENCES & ACCESSORIES

DEBRIS NETTING

Mutual's Flame Retardant Debris Netting satisfies OSHA regulations for debris containment, perimeter safety, overhead protection, and the all-inclusive "general duty" clause.



PART#	DESCRIPTION
14915-0-0	4' x 150' Orange FR Debris Netting
14915-91	4' x 150' Black FR Debris Netting
14915-91-8	8' x 150' Black NFR Debris Netting
14915-91-10	10' x 150' Black NFR Debris Netting
14915-91-12	12' x 150' Black FR Debris Netting

DEBRIS NETTING

Part# 14915

- Made of knitted polyethylene threads with reinforced border
- Lightweight, stays flexible in cold weather
- Economical and cost-effective • Hole opening 1/4"
- Available in Flame Retardant (FR) and Non Flame Retardant (NFR)



NATURAL WOOD SNOW/SAND FENCE

Part# 14910-9-48

With 4 strands of 14 gauge twisted wire supporting 3/8 x 1 1/2" natural wood slats, our traditional wood slatted fence is ideal for snow and sand control. Available in 4' x 50' rolls.

PRIVACY FENCE



GREEN PRIVACY FENCE

Part# 14899-150

Ideal for tennis courts, golf courses, baseball fields, or anywhere where personal privacy or wind protection is needed. Available in dark green high density polyethylene 68" x 150' rolls and in a 68" x 50' package.



BLACK PRIVACY FENCE

Part# 14899-91-150

Prime applications include urban construction sites where scaffolding is used. Also ideal for tennis courts, golf courses, baseball fields, or any place where privacy or wind protection is needed. Available in 68" x 150' rolls.



NEON LOCKING TIES

Part# 14970

Mutual's multi-purpose neon locking ties are perfect for many different color coding and fastening applications. They are available in 7" and 11" lengths and are packed in convenient 100 piece poly bags. Available Colors: Neon orange, neon pink, neon yellow, neon green, neon blue, neon red as well as standard red, yellow and natural.

BARRICADE TAPE PRODUCTS

TAPE PRODUCTS



BARRICADE TAPE Part# 17779

Designed to protect and identify above ground hazardous areas or elements such as construction sites, work areas, crime scenes, crowd control and any potentially dangerous areas. Mutual's barricade tape is available with more than 50 different in-stock legends. All legends are printed in crisp, bold black lettering on a yellow or red polyethylene material. These tapes can either be customized with an imprint of your company's name, logo and telephone number, or they can be purchased from Mutual's stock legend inventory. They are available in 3" x 1000', or 3" x 300' rolls. A larger 6" x 1000' roll is also available upon request. 10 per box.

2 Mil Caution Tape

A more economical version of Mutual's quality barricade tape. Please call for available legends.

REINFORCED BARRICADE TAPE

Part# 17776

Mutual's Reinforced Barricade Tape offers increased tensile strength providing extra safety for hazardous areas. This highly visible, highly durable tape is produced from polyethylene embedded with woven polyester fibers which allow it to retain its shape without sagging or stretching in harsh elements such as heat, rain, or wind. Stock legends include CAUTION (yellow) and DANGER (red) in 3' x 500' rolls. 8 per box. Other legends and private labeling are available, please call.



BIODEGRADABLE BARRICADE TAPE Part# 17773

The only truly biodegradable barricade tape on the market, these tapes are made of non-woven cellulosic material derived from wood pulp. They are completely non-toxic to humans, animals, and the environment. Complete degradation occurs outdoors in 6 to 24 months depending on specific environmental conditions. These tapes come in 3" x 500' rolls and are printed with black "CAUTION" on yellow or "DANGER" on red tape. 10 per box.



PROTECTIVE DISPENSER BOX

Part# 14978

This protective dispenser box is now available for Mutual's 3" x 1000' size of barricade tape. When used hand held or in conjunction with a flag staff or shovel handle, it becomes a handy dispensing unit. The dispenser box also protects the unused portion of the tape from becoming tangled or unwound, as well as making an excellent shelf display.

CAUTION TAPE



FLUORESCENT BARRICADE TAPE Part# 47000

Our non-adhesive Fluorescent Barricade Tape is excellent for marking hazards, danger areas and for delineating boundaries. Our tape is available in a variety of highly visible fluorescent colors (Pink, Blue, Green, Lime, Orange, Yellow, or Red). Tapes can be ordered either as solid rolls, or printed with a stock or custom legend.

STOCK LEGENDS

CAUTION ACID HAZARD
CAUTION ASBESTOS
CAUTION ASBESTOS HAZARD
CAUTION CAUSTIC HAZARD
CAUTION CAUTION CAUTION
CAUTION CHEMICAL HAZARD
CAUTION CONSTRUCTION AREA
CAUTION DO NOT ENTER
CAUTION ENERGIZED AREA
CAUTION ENTRY REQUIRES PROTECTIVE GEAR
CAUTION HARD HAT AREA

CAUTION HIGH VOLTAGE
CAUTION KEEP OUT
CAUTION MEN WORKING
CAUTION MEN WORKING OVERHEAD
CAUTION NO PARKING
CAUTION NO SMOKING
CAUTION OFF LIMITS
CAUTION OPEN TRENCH
CAUTION RADIATION AREA (MAGENTA/YELLOW)
CAUTION WET FLOOR
CAUTION WET PAINT

CAUTION AUTHORIZED PERSONNEL ONLY
CAUTION ENTRY REQUIRES PERMISSION
CAUTION RESTRICTED AREA KEEP OUT
CAUTION WET CONCRETE
CAUTION CUIDADO CAUTION
DANGER MICROBIAL HAZARD DO NOT ENTER
DANGER MICROBIAL HAZARD (W/CAUTIONARY INFO)*
DANGER ASBESTOS
DANGER ASBESTOS (W/CAUTIONARY INFO)*

DANGER ASBESTOS HAZARD
DANGER DANGER DANGER
DANGER DO NOT ENTER
DANGER HAZARDOUS AREA
DANGER HAZARDOUS AREA KEEP OUT
DANGER HAZARDOUS MATERIAL DO NOT ENTER
DANGER HIGH VOLTAGE AREA
DANGER KEEP OUT
DANGER CONFINED SPACE DO NOT ENTER
DANGER PELIGRO DANGER



TAPE TENDER™ Part# 47000-0-1

Dispense Barricade Tape easily and quickly with our Tape Tender™. Made from a highly durable polypropylene, this portable dispenser has a convenient cutting blade so you only use what you need. Will accommodate standard 3" x 1000' rolls.



REWIND REEL Part# 47000-0-2

The Rewind Reel makes Barrier Tape even easier to reuse. Just attach the tape to a tree, post or barricade and dispense as needed. Hang reel with tape still attached to the last post. Simply roll it back up after the job is through. (For 2" tape only.) • Quick • Reusable • Easy • Lightweight • Labor Saving • Zinc-plated steel

Tape is also available mounted to the reel.

BARRICADE TAPE PRODUCTS

TAPE PRODUCTS



**Specifically
Designed
for the
Paper
Industry!**



AVAILABLE LEGENDS* 3" X 45 YDS.

CAUTION CAUTION
CAUTION DO NOT ENTER
DO NOT ENTER
CAUTION MEN WORKING
CAUTION ASBESTOS HAZARD

CAUTION MEN WORKING OVERHEAD
DANGER DANGER
DANGER DO NOT ENTER
DANGER ASBESTOS HAZARD
HAZARDOUS AREA KEEP OUT

AVAILABLE LEGENDS* 2" X 45 YDS.

CAUTION CAUTION
BLACK STRIPE
KEEP OUT

DANGER DANGER
BLACK STRIPE

*Please Call for Availability of Specific Legends. Other Legends Are Also Available

REPULPABLE BARRICADE TAPE

Part# 17771

Repulpable barricade tape is another Mutual Industries exclusive. This tape was developed solely for use in paper mills where plastic contamination is a major problem. Blade lines are reduced because repulpable tape actually becomes part of the pulp and paper process. It is available in 3" x 45 yard rolls and 2" x 45 yard rolls, plain or printed with legends. 2", 30 rolls per case. 3", 20 rolls per case.



Glo-Reinforced Barricade Tape

Part #17772-139 Lime
Part #17772-145 Orange

Mutual's vinyl coated nylon reinforced fluorescent barricade tape is extremely strong and is reusable. This product is available stock in 3/4", 1", 2", 4" and custom widths all on 50 yd rolls.



Woven Barricade Webbing

Part# 17780

This Mutual product has a high, 100 lb. tensile strength in 3/4" widths and a 300 lb. tensile strength in 2" widths. Colors available are yellow/black/yellow, and red/black/red. Tape comes in 150' and 200' rolls.

BARRICADE TAPE



MICROBIAL HAZARD BARRICADE TAPE

Part# 17769-2 Mold

This specialized, barricade tape is used to warn people of a microbial (mold) hazard. Used during abatement operations as mandated by OSHA. This tape meets or exceeds all OSHA regulations and comes in 3" x 1000' rolls. Available in asbestos or lead hazard warning tape. 8 rolls per box.



ASBESTOS HAZARD WARNING TAPE

Part# 17769 Asbestos

LEAD HAZARD WARNING TAPE

Part# 17769-1 Lead

This specialized, white, polyethylene, barricade tape is used to warn people of an asbestos or lead hazard. The white tape is printed with both red and black ink and is used during abatement operations as mandated by OSHA. This tape meets or exceeds all OSHA regulations and comes in 3" x 1000' rolls. Available in asbestos or lead hazard warning tape. 8 rolls per box.

SPECIALIZED TAPE PRODUCTS

TAPE PRODUCTS



Avoid the problem of costly dig-ins to locate buried, non-metallic cables and pipelines with our Detectable Underground Tape. Providing you with double protection, this tape is easily located with an industrial grade non-ferrous metal detector before you dig, while it's highly visible colors make it easy to locate after the dig has begun.

DETECTABLE UNDERGROUND TAPE Part# 17774

Printed with a black legend on standard APWA colors, our Aluminum Foil tape is double laminated for extra protection. Available in Red, Orange, Yellow, Green, Blue and Purple.

CONFORMS TO THE FOLLOWING SPECIFICATIONS:

- NTSB-PSS-73-1
- American Gas Association
- OSHA 1926.956 (c) (1)
- DOT Office of Pipeline Safety USAS B31.8
- GSA Public Buildings Service Guide
- API RP 1109
- APWA Uniform Color Code
- Federal Gas safety regulations S 192-321 (e)
- 72-D-56



ITEM	COLOR	SIZE
Caution Buried Electric Line	Black/Red	All legends in the following sizes: 2" x 1000' 3" x 1000' 6" x 1000'
Caution Buried Gas Line	Black/Yellow	
Caution Buried Pipeline	Black/Yellow	
Caution Buried Sewer Line	Black/Green	
Caution Buried Telephone Line	Black/Orange	
Caution Buried Water Line	Black/Blue	
Caution Buried Oil Line	Black/Yellow	
Caution Buried High Voltage Line	Black/Red	
Caution Buried Fiber Optic Line	Black/Orange	
Caution Buried Reclaimed Water Line	Black/Purple	
Caution Buried Storm Drain Line	Black/Green	
Caution Buried Electric Line	Black/Yellow	
Caution Buried Irrigation Line	Black/Blue	
Caution Buried Potable Line	Black/Blue	
Caution Buried Non-Potable Line	Black/Blue	



OVERSPRAY SLEEVE Part# 17767

Lengthen the life of your spray painter hoses with Mutual's exclusive "Overspray Sleeve" Hose Protector. Durable 4-mil polyethylene protects your hoses from caked paint build-up, eliminating the need for clean-up as well as making them less likely to crack and need replacement. The bright yellow provides added visibility, reducing the risk of tripping, and ensuring a safer working environment. Installation is simple – just unroll the overspray sleeve and slip it over the hose. Mutual's own Sleeve Ties securely fasten the overspray sleeve onto the hose. As inexpensive as 14¢ per use!



UNDERGROUND

Vivid color-coded Underground Tapes quickly warn excavation crews of the existence of buried pipes and cables before damage can occur. Our non-adhesive polyethylene Underground Tape is a simple, economical way to protect buried utility lines. Tapes are impervious to alkalis, acids and other soil components.



NON-DETECTABLE UNDERGROUND TAPE Part# 17783

Printed with many stock legends or can be printed with your own custom wording. • Meets APWA recommended color codes.

Underground Tape should be installed 12" - 18" below ground level and 12" directly above buried pipes, cables and conduits, before final backfilling. Installation of Underground tape should be supervised by a professional.

ITEM	COLOR	SIZE
Caution Buried Air Line Below	Yellow	3"and 6" x 100'
Caution Buried Installation Line Below	Yellow	6" x 100'
Caution Buried Process Line Below	Yellow	6" x 100'
Caution Buried Cable TV Line Below	Orange	3"and 6" x 100'
Caution Buried Condensate Line Below	Blue	3"and 6" x 100'
Caution Buried Diesel Oil Line Below	Yellow	3"and 6" x 100'
Caution Buried Electric Line Below	Yellow, Red	3"and 6" x 100'
Caution Buried Fuel Line Below	Yellow	3"and 6" x 100'
Caution Buried Gas Line Below	Yellow	3"and 6" x 100'
Caution Buried High Voltage Line Below	Yellow, Red	3"and 6" x 100'
Caution Buried Natural Gas Line Below	Yellow	3"and 6" x 100'
Caution Buried Oil Line Below	Yellow	3"and 6" x 100'
Caution Buried Pipeline Below	Yellow	3"and 6" x 100'
Caution Buried Sewer Line Below	Green	3"and 6" x 100'
Caution Buried Telephone Line Below	Orange	3"and 6" x 100'
Caution Buried Steam Line Below	Yellow	3"and 6" x 100'
Caution Buried Utilities Underground	Yellow	6" x 100'
Caution Buried Utility Line Below	Yellow	6" x 100'
Caution Buried Water Line Below	Blue	3"and 6" x 100'
Caution Buried Cable Line Below	Orange	3"and 6" x 100'
Caution Buried Fiber Optic Line Below	Orange	3"and 6" x 100'
Caution Buried Reclaimed Water Below	Purple	3"and 6" x 100'
Caution Buried Storm Drain Line Below	Green	3"and 6" x 100'
Caution Buried Irrigation Line Below	Blue	3"and 6" x 100'
Caution Buried Non-Potable Water Line Below	Blue	3"and 6" x 100'
Caution Buried Potable Water Line Below	Blue	3"and 6" x 100'
Caution Buried Wastewater Line Below	Green	6" x 100'



REFLECTIVE TAPE PRODUCTS

TAPE PRODUCTS

VEHICLE CONSPICUITY (REFLECTIVE TRUCK TAPE)

Part# 17766

Federal law requires tractor trailers, flat beds, tankers etc. to have a 2" wide highly reflective tape on the sides and rear of each vehicle. Mutual's red and white striped tape (11" red, 7" white) comes in 2" x 50 yd rolls and meets all federal and state specifications. Specification compliance: Reflectorization Requirements: ASTM D4956-93B Type V. NHTSA conspicuity regulation: LS300 C - FP92. Effective 12/1/93.



FOIL BACKED PAVEMENT MARKING TAPE ENGINEER GRADE 4" X 50 YDS.

Part# 17793

CONSTRUCTION GRADE 4" X 100 YDS.

Part# 17792

Mutual's temporary foil backed marking tapes are ideal for construction or roadwork where temporary re-routing of traffic flow is required. These tapes are easily installed by hand with no special tools or equipment. In some circumstances, a primer sealer is also recommended. They are available in 4" widths in reflective yellow or white.



RETRO-REFLECTIVE TAPE

Part# 17786

ENGINEERING GRADE - ASTM TYPE

Mutual's pressure sensitive engineer grade reflective tape can be used indoors or outdoors, day or night. Enclosed glass beads reflect light making the tape highly visible at night or in blackout conditions. Available in 1", 2", and 4" widths, 10 yard or 50 yard rolls in red, white, blue, yellow, orange, and green. Custom widths up to 48" and lengths up to 216' available by special order.



REFLECTIVE BARREL TAPE

Part# 17794

Mutual's reflective barrel tape is perfect for refurbishing your old, tired-looking barrels. These high intensity, super engineering grade (ASTM Type II) barrel tapes meet all DOT specs and are available in orange or high intensity ASTM III white 50 yd rolls, in 4" or 6" widths. See our Retro-Reflective Engineering Grade (ASTM Type I) tape below when less stringent specifications are required.

REFLECTIVE HAZARD STRIPE TAPE

Part# 17798

Reflective hazard stripe tape catches light and sends it back to the source for exceptional night time visibility. 2", 3", and 4" widths in 10 yd and 50 yd rolls. Custom sizes available. Available in Yellow/Black, Orange/White, Red/White, and Black/White.



REFLECTIVE BARRICADE TAPE

Part# 17795

ENGINEERING GRADE ASTM I, II, III

Mutual's orange and white pre-stripped reflective barricade tape is ideal for repairing or making your own barricade. Engineering Grade ASTM Type I and Super Engineering Grade ASTM Type II barricade tape is available in 8", 10" and 12" widths in 50 yd rolls, and comes with 4" or 6" strips slanted left or right. Also available in High Intensity ASTM Type III. Please Inquire. See our Reflective Hazard Stripe tape when less stringent specifications are required.

SPECIALIZED TAPE PRODUCTS

TAPE PRODUCTS



ELECTRICAL TAPE **Part# 17809-750**

Our all weather vinyl electrical tapes are excellent for both indoor and outdoor applications. They offer flexibility and pliability to adhere and conform to the most irregular surfaces. These UL approved tapes are highly resistant to sun, water, oil, acids, alkalis, corrosive chemicals and aging. Uses Include: General splicing, harness wrapping, weather-proofing inside and outdoor connections and receptacles and color coding for quick and easy identification. Please specify color: Black, White, Red, Blue, Green, Grey, Orange or Yellow. 10 rolls per package.

COLOR VINYL AISLE-MARKING TAPE **Part# 17785**

Highly visible, tough, pressure-sensitive vinyl tapes are perfect for: color coding, aisle marking, duct sealing, abrasion protection, joint sealing, pipe wrapping, decorating, light bundling, packaging, and safety marking. Colors Available: yellow, red, white, orange, light blue, dark blue, brown, grey, light green, dark green, purple, and black. Also available in clear.

SIZES: 36 Yards x 1", 2", 3" 4", 5" or 6"
60 Yards x 1", 2", 3" 4", 5" or 6"



FLOOR TAPE APPLICATOR **Part# 17810**

- Stable, stand alone design
- Holds up to a 4" x 60 yd. roll floor marking or a 4" x 50 yd. roll pavement marking tape
- Tape is applied quickly and easily with no awkward bending or stooping
- Large wheel base ensures smooth placement of tape every time!
- Heavy duty construction stands up to years of constant use

Minimum assembly required.



PRESSURE SENSITIVE



**Custom
Printing
Available**

HAZARD STRIPE TAPE

Part# 17770

This 7-mil PVC vinyl, pressure-sensitive tape is required by OSHA 1910.44 to signal physical hazards. Available in 2", 3" and 4" widths on 18 and 36 yd rolls in blk/yellow, blk/white, red/white, and yellow/magenta colors.

Typical Color Codes:

- Black/Yellow - Physical Hazard/ Caution
 - Red/White - Fire Equipment/First Aid
 - Black/White - Traffic/Housekeeping
- 2", 24 per case, and 3", 16 per case.

"SUPER TOUGH" HAZARD STRIPE TAPE

Part# 17799

Mutual's polypropylene laminated "super tough" hazard stripe tape is an extremely durable, grease resistant, pressure sensitive tape that is ideal for applications where an extra measure of wear resistance is required. Available in 2", 3" or 4" widths in 18 or 36 yd rolls. Other sizes are also available, please inquire. Available colors: black/yellow, red/yellow, black/white, magenta/yellow. 2" - 24 per box, 3" - 16 per box, 4" - 12 per box. Custom printed legends available: • Slippery When Wet • Safety Glasses • Safety Footwear • Fork Lift Traffic • Hearing Protection • Fire Aisle-Keep Clear • Emergency Kit • Arc Flash Boundary



UPVC FLUORESCENT TAPE (PRESSURE-SENSITIVE)

Part# 17645

Enhance safety with our international red-orange pressure-sensitive fluorescent tape. Made of durable, scuff resistant vinyl, tape provides for fast and easy identification. Color resists fading from exposure to sunlight. Custom widths available. Tape can be used anywhere: • Aisle Marking • Fences • Pole • Barricades • Equipment • Hats • Steps • Machinery • Trucks

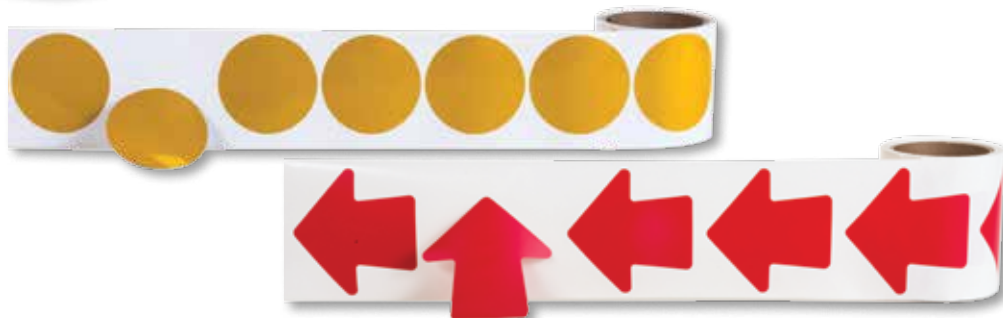

DIE-CUT ARROWS & CIRCLES

Part# 17650

Pressure-sensitive vinyl die-cut arrows and circles are great for aisle marking, inventory, color coding, and material identification, masking, package and box identification. Available in 12 colors plus clear.

A = Arrows and C = Circles. Also available in fluorescent paper. Please specify: FO - Orange, FG - Green, FP - Pink, FL - Lime/Yellow or FR - Red.

SIZES: 1000/rl x 1/2", 3/4" and 1"
500/rl x 2", 3", 4" and 5"

SPECIALIZED TAPE PRODUCTS

TAPE PRODUCTS



PIPE AND ELECTRICAL MARKERS

Part# 17808

Our vinyl pressure-sensitive pipemarkers are available in rolls 1" x 18 yds (SP-Series) and 2" x 18 yds (PM-Series). Labels come 72 markers per roll and are perforated every 9 inches. This is an inexpensive way to mark pipes and conduits. A clear laminate protects against harsh plant conditions. A continuously repeating legend, there is no perforation in the marker itself. See stock legends on next page.

MEDICAL PIPEMARKERS

Part# 17655

Each of our 3" x 3" pressure-sensitive vinyl markers is laminated and color coded to conform to specifications. Designed to fit pipes up to 1" O.D. Markers come in rolls of 50.

ELECTRICAL MARKERS

Part# 17652

Background color for all markers is Orange. Pipe Diameter – O.D. 3" or Larger / 3" or Smaller.

LEGEND	
AC	220 Volts
Air Conditioning	230 Volts
DC	240 Volts
Emergency	277 Volts
Exit Lights	440 Volts
Fire Alarm	460 Volts
Heating Circuit	480 Volts
Light & Power	550 Volts
Lighting	600 Volts
Power	2200 Volts
Single Phase	2300 Volts
Three Phase	2400 Volts
110 Volts	4160 Volts
115 Volts	4800 Volts
120 Volts	6900 Volts
208 Volts	

LEGEND	LEGEND COLOR	BACKGROUND COLOR
Carbon Dioxide	White	Grey
Cyclopropane	Black	Orange
Helium	White	Brown
Medical Air	Black	Yellow
Medical Vacuum	Black	White
Nitrogen	White	Black
Nitrous Oxide	White	Blue
Oxygen	White	Green



PIPE BANDING TAPE

Part# 17651

This pressure-sensitive vinyl tape provides a low cost way of color coding for identification of pipes. Colors are OSHA/ANSI approved. Use tapes by themselves or in combination with our pipe markers.

SIZES
1" x 18 yds
2" x 18 yds
4" x 18 yds
1" x 36 yds
2" x 36 yds
4" x 36 yds

DIRECTIONAL ARROWS

Part# 17653-00

Pressure-sensitive vinyl directional arrows are used to indicate flow direction of pipe content. Colors are OSHA/ANSI approved for pipe and conduit marking. They can be applied alone or in combination with our pipe markers. Colors: White on Red, White on Green, White on Blue, Black on White, Black on Orange and Black on Yellow.

PRESSURE SENSITIVE

Stock Pipe Marker Legend

LEGEND		
Acid	Fuel Oil	Propane Gas
Air	Gas	Rain Water
Air	Gasoline	Raw Water
Alcohol	Glycol	Return
Ammonia	Heating	Return
Argon	Heating Return	Return
Boiler-Feed	Heating Supply	Return
Brine	Heating Water Return	Sanitary Sewer
Carbon Dioxide	Heating Water Supply	Sewage
Caustic	Helium	Sludge
Chilled Water	Hi-Pressure Air	Sprinkler-Fire
Chilled Water Return	Hi-Pressure Condensate	Sprinkler-Water
Chilled Water Supply	Hi-Pressure Gas	Steam
Chlorine	Hi-Pressure Steam	Steam Return
Circulating Water	Hi-Pressure Water	Steam Supply
City Gas	Hot Water	Storm Drain
City Water	Hot Water Return	Storm Sewer
Cold Water	Hot Water Supply	Sulfuric Acid
Cold Water Return	Hydrogen	Supply
Cold Water Supply	Lo-Pressure Air	Supply
Compressed Air	Lo-Pressure Condensate	Supply
Compressed Air	Lo-Pressure Gas	Supply
Condensate	Lo-Pressure Steam	Tower Water
Condensate Return	Make-up Water	Treated Water
Condensate Supply	Medical Air	Unsafe Water
Cooling Water	Mixed Gas	Vacuum
Domestic	Natural Gas	Vacuum
Domestic Cold Water	Nitrogen	Vapor
Domestic Hot Water	Non-Potable Water	Vent
Drain	Oil	Vent
Drain Water	Oxygen	Waste
Drinking Water	Oxygen	Waste
Exhaust Air	Peroxide	Waste Water
Exhaust Steam	Plant Air	Water
Fire Automatic Sprinklers	Plant Water	Water
Fire-Dry Stand Pipe	Potable	Well Water
Fire Protect. Water	Potable Water	
Fresh Water	Process Water	

Pipe Diameter – O.D.
3" or Larger / 3" or Smaller

Our vinyl pressure-sensitive pipemarkers are available in rolls 1" x 18 yards (SP-Series) and 2" x 18 yards (PM-Series). Labels come 72 markers per roll and are perforated every 9 inches.



Materials Inherently Hazardous Yellow/Black Lettering

Denotes materials that are flammable, toxic, explosive, clinically active or poisonous

Fire Quenching Materials Red/White Lettering

Indicates sprinkler systems and fire protection equipment

Liquids of Inherently Low hazard Green/White Lettering

presents little or no risk to life or property. Non-toxic, non-poisonous, does not produce fire or explosions

Gases of Inherently Low Hazard Blue/White Lettering

identifies gases with little or no threat to life or property

SPECIALIZED TAPE PRODUCTS

TAPE PRODUCTS



DOUBLE FACE FOAM TAPE

Part# 17658

A 1/32" double coated cross-lined polyethylene foam. This closed cell foam has low water absorption, is flexible and resilient. Foam is coated on both sides with a rubber based pressure-sensitive adhesive, making this high-tack double face tape ideal for most mounting, holding and splicing applications. Great for mounting nameplates, posters or signs. This extra thick tape is also excellent for laminating all types of materials such as plastic, cork, cloth or felt. Indispensable for point of purchase displays.

SIZES
1/2" x 18 yds
3/4" x 18 yds
1" x 18 yds
1 1/2" x 18 yds
2" x 18 yds
1/2" x 36 yds
3/4" x 36 yds
1" x 36 yds
1 1/2" x 36 yds
2 x 36 yds

MUTUAL HOOK AND LOOP FASTENING TAPE AND COINS

Part# 152 Hook Part# 153 Loop

Mutual's hook and loop fastener is ideal for so many uses. It is great for mounting signs and plaques, holding down equipment in utility vans and trucks, as well as thousands of other applications. Aggressive adhesive backing sticks to most surfaces. Packaged in convenient 25 yard rolls.

Available in black or white:

TAPE: 3/4", 1", 1 1/2", 2", 4" widths in 25 yd rolls

COINS: 3/4" 1050 per roll and 7/8" 925 per roll



DUCT TAPE

Part# 17807

Mutual's DT260 8mil Duct Tape is a silver polyethylene single coated cloth with high tack rubber adhesive. Perfect for a variety of utility tasks. Meets UL723 requirements. 2" x 60 yd rolls packed 24 per case.



CUSTOM PRINTED CARTON SEALING TAPES

Part# 17659

Customize your shipments! For package and carton sealing, use our strong and economical shipping tapes. Water resistant with an aggressive permanent adhesive, these polypropylene tapes get the job done. Can print up to 2 colors maximum. Available in 2" x 55 yard rolls in Tan, White and Clear.

DUCT TAPE TEST DATA

Test	Typical Value	Typical Value (Metric)	Test Method
Thickness	8 mil	.2 mm	ASTM D-1000
Adhesion to Steel	9 oz/in	9.9 N/cm	PSTC-1
Adhesion to Backing	40 oz/in	4.4 N/cm	PSTC-1
Tensile Strength	22lb/in	38.5 N/cm	ASTM D-1000
Elongation	12%	12%	ASTM D-1000

PRESSURE SENSITIVE

NON-SKID ABRASIVE SAFETY TAPE

Part# 17768

Reduce the risk of slips and falls on ramps, stairs, slick concrete, and tile floors with Mutual's non skid abrasive safety tape. Made from black aluminum oxide with an aggressive adhesive to conform to irregular surfaces, this tape is extremely durable in high-traffic areas. Acrylic adhesive bond strengthens with time and heat for long wear.

- Helps with OSHA compliance 1910.263(3)
- Prevents unnecessary slips and falls

Available stock sizes: 1" x 60', 2" x 60', 4" x 60', 6" x 60' and die cuts ¾" x 24", 6" x 24", 5½" x 5½" in black. **Other sizes are also available by special order.** Also by special order are dark blue, lt. blue, green, white, yellow, red, clear, neon pink, neon orange, and neon yellow.



WARNING ANTI-SKID TAPE

Part# 17810

Our warning anti-skid tape identifies hazardous areas with a warning printed continuously on the tape plus has the added protection of an anti-skid overcoat. You can adhere to various floor surfaces, depending on need, to reinforce warning.



DESCRIPTION
Caution
Caution Hard Hat Area
Stripes
Authorized Personnel Only
Caution Watch Your Step



NON-SKID HAZARD STRIPE TAPE

Part# 17796 Hazard Stripe

Non-Skid Glo-in-the-Dark Tape

Part# 17797 Glo-in-the-Dark

Two versions of Mutual's high quality non-skid tape that are ideal for a wide variety of uses. These tapes are two tapes in one, providing high-visibility marking with non-skid protection.

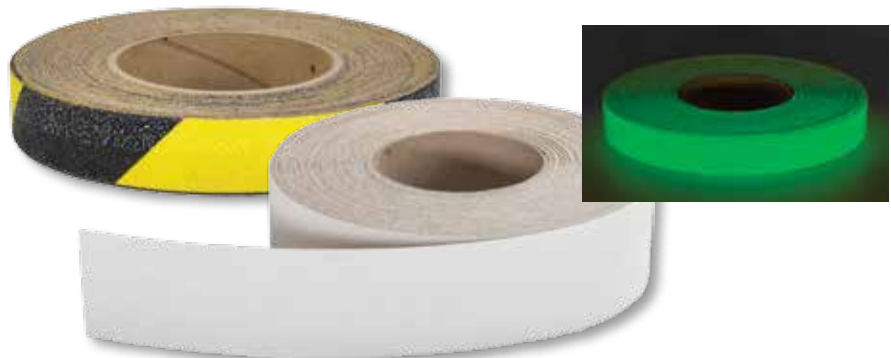

SPECIALIZED TAPE PRODUCTS

TAPE PRODUCTS



FLOOR DECALS

Part# 27000

Mutual's Floor Decals are 4-mil pressure-sensitive vinyl and are overlaminated with a 20-mil clear heavy-duty "pebbled" non-skid vinyl. Available in 17½" overall diameter. Adhesive backing will adhere to virtually any floor.

- Reinforce Safety Procedures in Hazardous Areas
- Highly Visible Reminder at Entries
- Self Adhesive Keeps Sign Firmly in Place
- Non-Skid Surface Eliminates Slippery Surface
- FD050 & FD051 Glow in the Dark - Can be Used in Conjunction, with an Escape Route Plan.

We have a variety of stock legends to choose from or have a custom legend created to fit your needs.



LEGEND	CLASS	SIZE	
Non-Flammable Gas	2	4" x 4"	
Flammable Gas	2		
Inhalation Hazard	2		
Flammable Liquid	3		
Flammable Solid	4		
Spontaneously Combustible	4		
Dangerous When Wet	4		
Oxidizer	5.1		
Organic Peroxide	5.2		
Poison	6		
Stow Away From Food	6		
Infectious Substance	6		
Corrosive	8		
Misc. Hazardous Material	9		
Cargo Aircraft Only			4" x 5"
Empty			6" x 4"
Explosive 1.1, 1.2, or 1.3	1	4" x 4"	
Explosive 1.4	1		
Blasting Agent 1.5	1		
Explosive 1.6	1		
Oxygen	2		

D.O.T SHIPPING LABELS

Part# 900

Meet DOT Rule HM-181 with our durable vinyl labels. Potential liability in the handling of hazardous materials has reached crisis proportions. To comply with DOT safety requirements, all air, water, rail and highway packages and containers must be properly labeled for quick and easy recognition. Simply remove label from backing sheet and apply to clean surface. All labels include UN class numbers and meet DOT specification 49CFR172.400 for color, size and durability. Labels are packaged in rolls of 100 and 500. • Pressure-sensitive • Resistant to weather • Resistant to chemicals • Resistant to abrasion



PACKAGING LABELS

Part# 901

Avoid costly and unnecessary damage to your product with our packaging labels. These labels help prevent damage from happening, and can also be helpful when filing an insurance claim if an accident does occur. Labels are packaged in rolls of 500.



HAZARDOUS WASTE LABELS

Part# 902

Proper labeling of all accumulations and shipments of hazardous waste by generators is required by DOT and EPA regulations. Satisfy compliance of the DOT Rule HM-181 with our Hazardous Waste Labels. Our 6" x 6" and 4" x 4" exterior-grade labels are resistant to weather as well as underground environments (as required by EPA standards). Available in rolls of 100 and 500.

LABELS - Have your Hazardous Waste Labels personalized by ordering our custom imprinted labels. Preprinted labels eliminate filling out the information by hand, paperwork snarls, chances of illegible handwriting and transposed numbers.



LEAD ABATEMENT LABELS

Part# 904

These 3" x 5" Danger/ Caution labels quickly alert the public to the presence of lead contaminants. Printed on pressure-sensitive paper for easy application, they come packaged 500 labels per roll.

ASBESTOS HAZARD LABELS

Part# 903

Danger labels are printed on pressure-sensitive paper. Available in a variety of sizes, 500 per roll. Caution and Asbestos Free/Non Asbestos labels are 3" x 5" self-wound vinyl labels, 500 per roll. Our vinyl, pressure-sensitive asbestos labels are available in rolls of 2" x 18 yards. Labels are perforated every nine inches, with 72 labels per roll. Legends are printed on OSHA approved background colors and are protected by a clear laminate.

SPECIALIZED TAPE PRODUCTS

TAPE PRODUCTS



**Custom
Printing
Available**



HOMELAND SECURITY PRODUCTS

Now Available Specialty Homeland Security Barricade Tape, Adhesive Tape and Triage Tags

Be prepared for any Homeland Security Emergency and give your customer's options. Our speciality tape and tags will carry appropriate legends that will help organize departments or areas in case of an emergency, as well as assist in newly adopted security measures. Tapes are available in our standard specifications for barricade tape and adhesive tapes. Custom orders are also available.



DESCRIPTION	SIZE
Non Adhesive Barricade Tape	3" x 1000'
Printed Hazard Warning Tape	2" x 18 yds
Triage Tag	4 1/4" x 8 11/16"
Homeland Security Hazmat I.D. Kit	13" x 18 13/16" x 6 5/16"
Homeland Security Medical I.D. Kit	13" x 18 13/16" x 6 5/16"

SIGNS



SIZE	QUANTITY	MATERIAL
11" x 17"	100/Pkg	Paper
14" x 20"	1/Pkg	.010 Plastic
14" x 20"	100/Pkg	Paper
10" x 14"	100/Pkg	Paper
14" x 18"	200/Pkg	Paper
11" x 17"	100/Pkg	Paper

ASBESTOS HAZARD

Highly visible Danger Signs alert personnel to potential asbestos hazards. Printed red and black on white stock. Available in English and Spanish. Meets OSHA 1910-1001 standards for job site safety. Specify E for English and S for Spanish. Add as suffix to catalog number.



SIZE	QUANTITY	COLOR
14" x 20"	100/Pkg	Black on Orange
14" x 20"	100/Pkg	Black on Yellow
14" x 20"	100/Pkg	Black /Red on White

LEAD HAZARD

Highly visible Warning Signs alert personnel to potential lead hazards. These 14" x 20" paper signs meet Federal OSHA 1926-62 ruling for job site safety. Specify E for English and S for Spanish. Add as suffix to catalog number.

FLAGGING TAPE

MARKING PRODUCTS

“ULTRA” FLAGGING/SURVEYING TAPE (PVC)

Part# 16001 Ultra Glo Colors

Part# 16002 Ultra Standard Colors

Part# 16002-S/D Ultra Stripes/Dots

Mutual’s “ULTRA” tape is constructed from high quality, economically priced embossed PVC. The tape can withstand 0° temperatures without cracking, fading or tearing. Our vibrant colors

are the brightest and boldest available and UV stabilized to provide long-lasting color retention. Whether used for surveying, mapping, forestry, tagging, roping off an area, or any other marking application, Mutual’s “ULTRA” tape sets a new standard. Tapes are stocked in 1^{3/16}" widths, but are available in widths from 1/2" to 54", in over 41 colors. When ordering, ask for “Ultra” by name. 12 rolls per box, 144 per case.



DESCRIPTION	COLOR	PATTERNS
Ultra Flagging	Glo Orange, Glo Pink, Glo Red, Glo Blue, Glo Lime (Grn), Glo Chartreuse (Ylw), Yellow, White, Green, Orange, Red, Blue, Forest Grn, Pink, Black	STRIPES: Green/White, Red/White, Blue/White, Black/White, Orange/White, Yellow/White, Orange/Black, Blue/Black, Yellow/Black, Red/Black, Forest Green/Black DOTS: Yellow/Black, Blue/White, Red/White, Orange/White, White/Green, White/Red, Orange/Black, White/Black, Yellow/Red, Red/Black, Pink/Black
Heavy-Duty Tundra	Glo Orange, Glo Pink, Glo Red, Glo Blue, Glo Lime (Grn)	Solid Colors Only
Biodegradable	Glo Orange, Red, White, Blue, Yellow	Solid Colors Only



BIODEGRADABLE FLAGGING TAPE
Part# 17781

Mutual is the only manufacturer of a truly biodegradable flagging tape in the United States. These tapes are made of non-woven cellulosic material derived from wood pulp. They are completely non-toxic to humans, animals, and the environment. Complete degradation occurs outdoors in 6 to 24 months depending on specific environmental conditions. Some common uses include trail marking, agricultural, and horticultural applications. These tapes come in 5 colors and are stocked in 1" x 100' rolls, with widths from 1" to 48" available. 12 rolls per box, 144 per case.



-40°F "TUNDRA" FLAGGING TAPE (PVC)
Part# 17777

This new and improved heavy-duty "TUNDRA" flagging tape is nationally recognized as the best quality on the market today. It is made from a superior grade of 5-mil non embossed PVC with a low cold crack rating (up to -40°F temperatures) and extra U.V. inhibitors. "TUNDRA" is reasonably priced for those who don't mind paying a little extra for the best product. These tapes are stocked in 1³/₁₆" widths, but are available in widths from 1/2" to 54" in 5 glo colors. When ordering, ask for "TUNDRA" by name. 12 rolls per box, 144 per case.



PRE-MADE AERIAL TARGETS
Part# 15000 6-mil. Iron Cross
Part# 15500 6-mil. Bulls-Eye
Part# 15600 Harlequin Bulls Eye
Part# 15700 Harlequin Iron Cross

Mutual Industries designed and manufactured these specialized aerial targets to save time and labor costs involved in painting targets for aerial surveying. Mutual's pre-made targets are manufactured on heavy 6-mil or 3-ply reinforced vinyl, and come in either a bull's-eye or iron cross design. These premade targets, complete with grommets, are 100% reusable.



AERIAL PANELING MATERIAL
Part# 16006 Heavy 6 mil
Part# 15800 Harlequin 3 ply

Mutual's aerial panel material is the finest quality and is available in, 12", 18", and 24" widths on 100 yard rolls of either 6-mil PVC or 3-ply, 100' reinforced Harlequin (black on one side and white on the other).



PRINTED FLAGGING TAPE
Part# 16003

Mutual's flagging/surveying tape is highly visible and is available in 1 1/2' x 50 yd rolls printed with the following legends and colors glo orange (GO) or glo pink (GP):

- KILLER TREE W/ CROSSBONES (GO) • SKULL AND CROSSBONES (ONLY) (GO)
- DANGER DANGER (GO) • PROPERTY LINE (GP) • WETLAND DELINEATION (GP)
- PEST MGT (GP) • SPOT FIRE (GO) • WETLAND BOUNDARY (GO), (GP)
- TIMBER HARVEST BOUNDARY (GP) • RIPARIAN MANAGEMENT ZONE (GP)
- STREAMSIDE MANAGEMENT ZONE (GP)

9 rolls per box, 100 per case.

MARKING & MEASURING PRODUCTS

MARKING PRODUCTS

6" STAKE WHISKERS

Part# 15900

Mutual's Stake Whiskers are unique marking devices for many types of surface applications. Brightly colored, durable and resilient, they are easily and conveniently attached to wooden stakes or to 60-penny nails. These extraordinary markers are ideal for highway and road construction, grade stakes, hubs, reference points, bench marks, center lines, utility line paths, forestry, agriculture, exploration and seismographic applications. Available colors are blue, red, orange, yellow, white, green, glo-pink, and glo-orange. 500 whiskers per box.



LUMBER CRAYONS

Part# 16100

Smear resistant, water resistant and fade resistant, Mutal's extruded 4½" x ½" hexagonal crayons will outlast wax or chalk crayons. They are ideal for use on lumber, steel, concrete and most rough surfaces. Available Colors: red, yellow, blue, black, green. 12 per box/ 2 gross case.

CARPENTER PENCILS

Part# 16200

Superior quality, long lasting, easily sharpened flat lead pencils are ideal for many construction marking uses. Now these pencils come packaged in an attractive point-of-purchase display, packaged 6 sleeves of 12, 72 pencils per box.

RED EYE NAIL MARKER

Part# 14999

Made of fluorescent red/orange vinyl-impregnated nylon fabric, these nail markers are so tough they are almost impossible to tear. Measuring a 1" square with a ⅛" or ¼" center hole, they are also available in custom-made sizes. 50 bags, 70 per bag.

PAINTS

TRAFFIC STRIPE PAINT Part# 82400

Mutual's 20 oz. water-based paint formulated with high pigment solids is not affected by water. Perfect for a wide range of applications including blacktop, concrete, gravel, and dirt. Available in white and yellow. 12 cans per box.



ATHLETIC FIELD PAINT Part# 20624

Mutual's 20 oz. water-based paint is specially formulated to not harm grass, yet is not affected by water for maximum durability. Available in white and yellow. 12 cans per box.



KRYLON® INVERTED MARKING PAINT Part#-See Color Chart

Ideal for a wide variety of surveying and marking applications, these paints work well on gravel, black top, grass, stone, concrete and other surfaces. Convenient spray through cap and non-clogging tip provide reliable one-stroke application. Solvent based, VOC compliant, no lead marking paint is available in 20 oz cans. 12 cans per box.

AVAILABLE COLORS: FLUORESCENT MARKING PAINTS

- SO3613V-FLO SAFETY RED
- SO3614V-FLO NEON GREEN
- SO3615V-FLO PURPLE
- SO3702V-FLO ORANGE
- SO3622V-FLO HOT PINK
- SO3701V-FLO RED/ ORG

GENERAL PURPOSE MARKING PAINTS

- SO3550V-ASPHALT BLACK
- SO3640V-SILVER

A.P.W.A. MARKING PAINTS

- SO3631V-APWA GREEN
- SO3611V-APWA RED
- SO3821V-APWA HI VIS YELLOW
- SO3621V-APWA BLUE
- SO3731V-BRIGHT ORANGE
- SO3823V-SAFETY YELLOW
- SO3900V-UTILITY WHITE
- SO3500V-CLEAR*

*WATER BASED



MUTUAL 20OZ. INVERTED SPRAY PAINT Part# for Mutual Inverted Tip Paint-See Color Chart

Mutual's Water-Based Inverted Spray Paints offer name brand quality at a more economical price. 12 cans per box.

AVAILABLE COLORS: FLUORESCENT MARKING PAINTS

- 652-10 #652 WHITE
- 654-179 #654 FLO RED
- 657-145 #657 FLO ORG
- 658-7945 #658 FLO RED/ORG
- 679-175 #679 FLO PINK
- 668-139 #668 FLO GREEN

A.P.W.A. MARKING PAINTS

- 669-125 #669 FLO BLUE
- 671-79 #671 SAF RED
- 655-39 #655 SAF GRN
- 677-41 #677 CAUT YLW
- 653-25 #653 PRECAUT BLUE
- 670-45 #670 ALERT ORG
- 676-141 #676 HI-VIS YLW

TURF MARKING MACHINE Part# 20841

Used with Mutual's Athletic Field Paints, this machine easily creates 2" to 4" lines on athletic fields or other turf surfaces.



TRAFFIC PAINT MACHINE Part# 20840

Designed for Mutual's Traffic Stripe Paints, this easy-to-use machine applies crisp even lines to concrete and asphalt.



INVERTED MARKING ACCESSORIES HAND HELD WANDS

Part# 4000-12 12" Part# 4000-34 34"
These convenient hand held wands make application clean and easy. Wands are available in 12" and 34" lengths. Belt holster also available.



MARKING & MEASURING PRODUCTS

MARKING PRODUCTS



WIRE MARKING FLAGS

Part# 15901

Mutual's wire marking flags are rated #1 in the industry for quality and durability. A heavy gauge PVC flag is used that will not tear in the wind or crack from cold weather. An exclusive hot melt glue system insures that the flags stay on the wire and not on the ground. Available in 3 sizes, 2.5" x 3.5" x 21", 2.5" x 3.5" x 30", 4" x 5" x 30".

Applications of Mutual Marking Flags include:

- Surveying • Grading • Forestry • Agriculture • Construction
- Utilities • Trenching • Landscaping • Highway Construction
- Farming • Pesticide Posting

PRINTED WIRE MARKING FLAGS

Part# 15902

Mutual now offers our 4" x 5" x 30" wire marking flags printed with all of the most popular utility legends. Pesticide application flags are also available. Call us with your specific requirements. Custom printing is also available-only a 2000 flag minimum and a small one time screen fee is required.

NYLON MASON LINE

Part# 14661 Twisted **Part# 14662** Braided

Mutual's high-quality #18 twine is made from 100% filament nylon that is resistant to abrasion, rot, mildew, marine growth, petroleum and chemicals. This nylon line is ideal for masonry, chalk line, duck decoy line, net repair and many other general uses.

Available in Twisted or Braided, Glo-Lime, Glo-Orange, Glo-Pink, Glo-Yellow, Green, White, and Yellow. In ¼ lb, ½ lb and 1lb size rolls.





THE POINTER (BLACK)
Part# 82391

Mutual's quality black permanent marker has a fine tip, packaged 12 to a box.



WHITE PAINT CRAYONS
Part# 82010

Solid paint in the form of a crayon that marks on any surface: rough, oily, wet, hot or cold (-50 to 150 degrees F). 12 per box.



MAXI MARKER (BLACK)
Part# 82191

Large barrel permanent marker that creates highly visible lines. Extra large chisel tip with a large ink reservoir, packaged 12 per box.

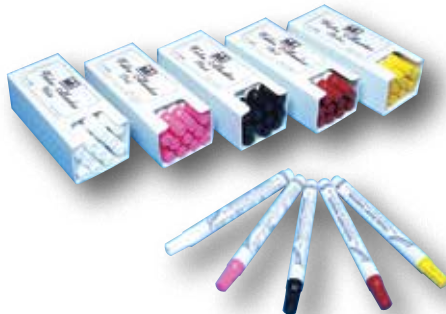

VALVE PAINT MARKERS
Part# 800

Mutual's valve paint markers provide 10 times the life span of regular fiber tip markers due to their large reservoirs and replaceable nibs. Available in black, red, pink, yellow, or white, 12 per box.



PENCIL CHINA MARKERS
Part# 82200

Mutual's pencil china markers are ideal for marking on many different surfaces. Each has a pull cord for easy sharpening. Available in black, red or white, 12 per box.



#31 SERIES MECHANICAL MEASURING WHEEL
Part# 17701

This style has a 10" diameter wheel with kickstand. Its 5 digit counter measures up to 10,000 units. Equipped with a telescopic aluminum handle. Stocked in feet and inches increments, it is also available to order in feet and tenths as well as meters and centimeters.



#45 SERIES MECHANICAL MEASURING WHEEL
Part# 17702

This style has a 14.3" diameter wheel with kickstand. Its 5 digit counter measures up to 10,000 units. Equipped with a telescopic aluminum handle. Stocked in feet and inches increments, it is also available to order in feet and tenths as well as meters and centimeters.



DW12 MEASURING WHEEL
Part# 17703

This style has durable twin 4 inch wheels for stable and accurate measuring on hard indoor and outdoor surfaces. Its 5 digit counter measures up to 10,000 units. Equipped with a telescopic aluminum handle. Stocked in feet and inches increments, it is also available to order in feet and tenths as well as meters and centimeters.



MEASURE MARKER
Part# 17704

This measuring wheel and paint marking combo has dual 6" diameter wheels and a 5 digit counter which measures up to 10,000 units. Stocked in feet and inches increments, it is also available to order in feet and tenths as well as meters and centimeters.

PENNANTS & MARKERS

PENNANTS PRODUCTS



Specifications
 Size: 1/4"
 Put Up: 600/1200 ft.
 Lbs/100': 1.2 lb.
 Unit Weight: 14.4 lb.
 Tensile Strength: 1250 lb.
 Package Type: Spool



1/4" POLY-SAFETY ROPE

Part# 14980

Mutual's 100% 3-strand twisted polypropylene rope is great for construction, golf courses, crowd control, etc. Our safety yellow and black rope is highly visible and weather resistant. Available in 600 ft. and 1200 ft. lengths

YELLOW POLY-SAFETY ROPE

Part# 14980-41-375 3/8" x 600'

MANILA POLY-SAFETY ROPE

Part# 14980-0-375 3/8" x 600'

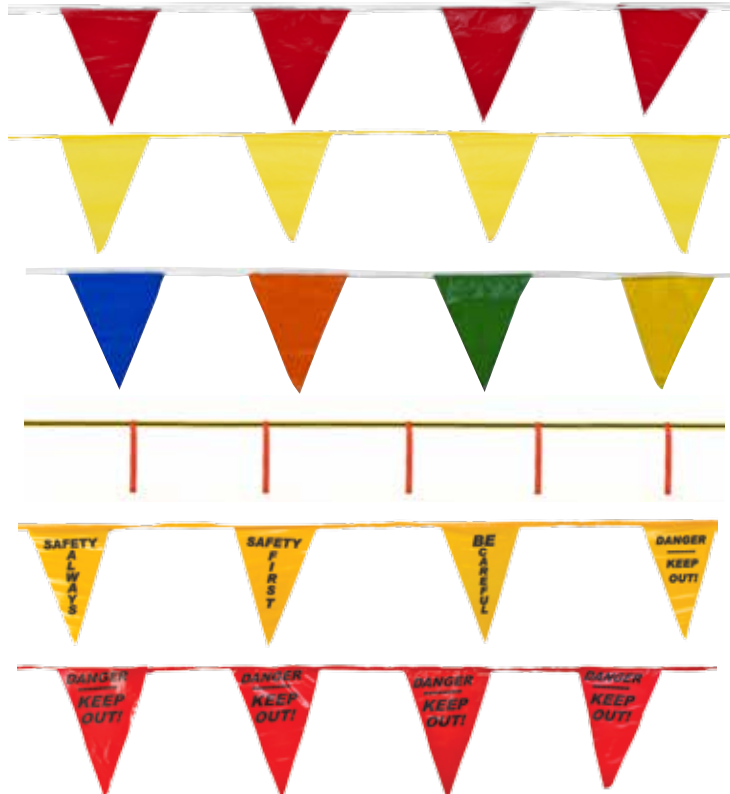

PENNANT FLAGS

Part# 14991 Multi **Part# 14991-41** Yellow

Part# 14991-79 Red

Mutual's pennant flags come in 60' long strings containing 36 brightly colored 9" x 12" pennants. Ideal for use at construction sites, scaffolding, wet floors, sporting events, grand openings, open houses, and other practical applications. The pennants are available in solid red, solid yellow, solid orange, red/white, yellow/white, orange/white, yellow/black, and a 6-color combination. 10 strands per box.

SUPER MULTI PENNANT FLAGS

Part# 15991

Same as above but sized 9" x 12" x 100'.

HULA SKIRT PERIMETER MARKER

Part# 14976

Mutual's highly visible perimeter marker consists of Glo-Reinforced barricade tape strips sewn onto our own 3/4" x 50 yard Yellow/Black/Yellow woven barricade webbing. This product provides extra visibility and protection for marking-off dangerous and restricted areas. 12 strips every 12".

PENNANT FLAGS WITH LEGENDS

Part# 15906

Oversized 12" x 18" pennants spaced every 15" on a 60' length roll. Yellow pennants have alternating legends which read: "Danger Keep Out", "Safety Always", "Be Careful", "Danger Ahead", "Safety First." Red pennants have one legend which reads: "Danger Keep Out." Sold by the strand.

OSHA requires perimeter marking for any above ground construction area, flat roof job, and open upper level construction.



Fold up design!

METAL OSHA PERIMETER MARKER STANCHION
Part# 15903

- Convenient fold-up design sets up in seconds
- Provides secure attachment point for perimeter markers
- Maximum recommended spacing, 50' apart
- Weighs only 23 lbs. and stands 39" in height

OSHA PERIMETER MARKER STANCHION
Part# 15903-3

Mutual's standard perimeter marker stanchion is made from durable, high visibility, high-impact polyethylene. It features a reinforced loop to easily attach perimeter markers at the top. A weighted rubber base is included with each stanchion for stability.

Post: 39" x 7.5"
Base dimensions: 30" x 14"
Base Weight: 30 lbs

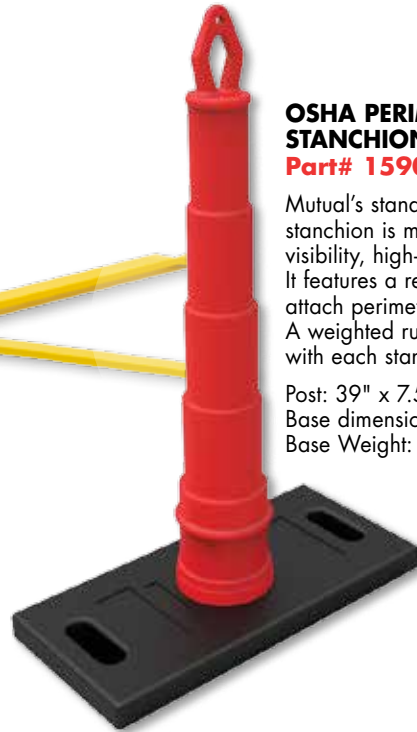

OSHA PERIMETER MARKERS

Required by OSHA for perimeter markings of above ground construction areas, flat roof jobs, and open upper level construction. Mutual's OSHA Perimeter Marker is 105 ft. in length and exceeds the required 500lb. breakstrength and contains (42) 12" x 18" flags.

Available in 3 Colors:

Part# 15903- 41 Yellow

Part# 15903- 79 Red

Part# 15903- 7941 Red/Yellow Combo

OSHA REBAR CAPS

PROTECTION PRODUCTS



**Meets OSHA
Requirement 344.90**

LARGE ORANGE OSHA REBAR CAPS

Part# 14640-5 Large 50 per box
Mutual's patented OSHA rebar caps are made of space age high density polymer to protect against impalement injuries. These high quality caps fit rebar #9-#16.



**Meets OSHA
Requirement 344.90**

ORANGE OSHA REBAR CAPS

Part# 14640-4 Standard
100 per box and 25 per box
Mutual's patented OSHA rebar caps are made of space age high density polymer to protect against impalement injuries. These high quality caps fit rebar #4-#8.



**Meets OSHA
Requirement 344.90**

LIME OSHA REBAR CAPS

Part# 14640-138-4 100 per box
Mutual's patented OSHA rebar caps are made of space age high density polymer to protect against impalement injuries. These high quality caps fit rebar #4-#8.



SAFETY HARNESS & LANYARD

Part# 50077
Lightweight Universal Size Harness with 1 back D-ring, mating buckle leg closures. Includes 1 lanyard keeper and work belt loops. 6 ft. shock absorber lanyard attached.

FALL PROTECTION



LARGE REBAR CAPS

Part# 14640-2 Large Rebar 100 per box
Mutual's Mushroom style rebar safety caps provide the protection you need from protruding rebar at your construction sites. These high-quality mushroom style caps are brilliant orange for excellent visibility, Large for rebar up to 2" diameter. Mushroom caps are of use where the danger of impalement is not present.



STANDARD REBAR CAPS

Part# 14640-3 Standard 500 per box
Mutual's Mushroom style rebar safety caps provide the protection you need from protruding rebar at your construction sites. These high-quality mushroom style caps are brilliant orange for excellent visibility, and are available in standard for rebar #3 - #9. Mushroom caps are of use where the danger of impalement is not present.



TENT CAPS (REBAR - WHITE)

Part# 14610-2 Large 100 per box
Designed for the party and rental industries, Mutual's tent caps prevent potential injury from protruding rebar. These caps are made of a tough ABS plastic and are white to provide visible yet unobtrusive protection.



LIME STD REBAR CAPS

Part# 14640-138-3
Mushroom style rebar safety caps provide the protection you need from protruding rebar at your construction sites. These high-quality mushroom style caps are brilliant lime for excellent visibility. 500 per box.



SAFETY HARNESS

Part# 50076
Lightweight Universal Size Harness with single back D-ring. Mating buckle leg closures.
Weight: 2.3 lbs.
Material: Polyester Web Steel D-rings & mating buckles
Stress Indicators: YES
Webbing -Min.Tensile Strength: 6,000 lbs.

SHOCK-ABSORBING LANYARD

Part# 50075
6 ft. Shock absorbing lanyard with 2 locking snap hooks.



PROTECTION PRODUCTS

PREMIUM CLASS 2 ANSI VESTS — ZIPPER

ANSI CLASS 2 MESH BACK LIME SURVEYOR VEST Part# 16369

- 4" orange/silver/orange reflective tape on front and back
- 3.65 oz breathable, extra durable 100% knit polyester high visibility material on front with mesh back for added comfort
 - 4 outside pockets, 1 inside pocket
 - Zipper closure
- Stock sizes: L-4XL, other sizes made to order



All vests on this page feature 2 lower flap pockets, a chest cell phone pocket, and an additional breast pocket on the outside. One inside breast pocket is also provided.

ANSI CLASS 2 MESH BACK ORANGE SURVEYOR VEST Part# 16368

- 4" lime/silver/lime reflective tape on front and back
- 3.65 oz breathable, extra durable 100% knit polyester high visibility material on front with mesh back for added comfort
 - 4 outside pockets, 1 inside pocket
 - Zipper closure
- Stock sizes: L-4XL, other sizes made to order



Flap Pockets

ANSI CLASS 2 MESH LIME SURVEYOR VEST Part# 16369-1

- 4" orange/silver/orange reflective tape on front and back
 - 3.65 oz breathable, extra durable 100% knit polyester ANSI certified mesh
 - 4 outside pockets, 1 inside pocket
 - Zipper closure
- Stock sizes: L-4XL, other sizes made to order



ANSI CLASS 2 MESH ORANGE SURVEYOR VEST Part# 16368-1

- 4" lime/silver/lime reflective tape on front and back
- 3.65 oz breathable, extra durable 100% knit polyester ANSI certified mesh
 - 4 outside pockets, 1 inside pocket
 - Zipper closure
- Stock sizes: L-4XL, other sizes made to order



WE DO LOGOS



MiViz offers custom letter/logo screening on all of our traffic safety wear. We can custom imprint your logo or any text you wish to display on our ANSI Outerwear.

ANSI CLASS 2

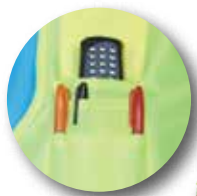

ANSI CLASS 2 LIME SOLID DELUXE DOT Part# 16334

ANSI CLASS 2 ORANGE SOLID DELUXE DOT Part# 16334-45

- 4" high visibility fabric with double 1" silver reflective stripes
- 3.65 oz breathable, extra durable 100% knit polyester high visibility lime material
- ANSI approved mesh side vents for comfort
- Inside left breast pocket with a 2 tiered pencil pocket
- Matching high visibility trim all around
- Zipper closure
- Stock sizes: L-4XL, other sizes made to order

ANSI CLASS 2 PREMIUM LIME/BLACK SAFETY VEST Part #16515-138

- Surveyor Style with Multiple Pockets
 - Reinforced Zipper Closure
- Ultra Cool 100% Polyester Mesh Fabric
- Black Accents on High Wear Areas
 - Mic Tabs on Both Shoulders
 - 3" Orange/Silver/Orange Reflective Stripes
- Hi-Viz ANSI Lime Color



ANSI CLASS 2 LIME DELUXE DOT MESH Part# 16343

- 4" high visibility lime fabric with double 1" silver reflective stripes
- 3.4 oz durable extra breathable 100% knit polyester mesh high visibility lime material, and solid knit side panels for durability
 - ANSI approved mesh side vents for comfort
 - Inside left breast pocket with a 2 tiered pencil pocket
 - Matching high visibility trim all around
 - Zipper closure
- Stock sizes: L-4XL, other sizes made to order



ANSI CLASS 2 ORANGE DELUXE DOT MESH Part# 16343-45

- 4" high visibility orange fabric with double 1" silver reflective stripes
- 3.4 oz durable extra breathable 100% knit polyester mesh high visibility lime material, and solid knit side panels for durability
 - ANSI approved mesh side vents for comfort
- Inside left breast pocket with a 2 tiered pencil pocket
 - Matching high visibility trim all around
 - Zipper closure
 - Stock sizes: L-4XL, other sizes made to order



PROTECTION PRODUCTS

PREMIUM CLASS 3 ANSI VESTS — ZIPPER



ANSI CERTIFIED
MESH

ANSI CLASS 3 ORANGE MESH

Part# 16393

- 3.4 oz durable, extra breathable high visibility orange ANSI certified mesh material with sleeves
- 4 outside pockets, 1 inside pocket
- Zipper closure
- 4" lime/silver/lime reflective tape on front and back
- Stock sizes: L-4XL, other sizes made to order



ANSI CERTIFIED
MESH

ANSI CLASS 3 LIME MESH

Part# 16391

- 3.4 oz durable, extra breathable high visibility lime ANSI certified mesh material with sleeves
- 4 outside pockets, 1 inside pocket
- Zipper closure
- 4" orange/silver/orange reflective tape on front and back
- Stock sizes: L-4XL, other sizes made to order



POCKETS

ZIPPER

ANSI CLASS 3 ORANGE SOLID

Part# 16394

- 3.65 oz breathable, extra durable 100% knit polyester high visibility orange material with sleeves
- 4 outside pockets, 1 inside pocket
- Zipper closure
- 4" lime/silver/lime reflective tape on front and back
- Stock sizes: L-4XL, other sizes made to order



ANSI CLASS 3 LIME SOLID

Part# 16392

- 3.65 oz breathable, extra durable 100% knit polyester high visibility lime material with sleeves
- 4 outside pockets, 1 inside pocket
- Zipper closure
- 4" orange/silver/orange reflective tape on front and back
- Stock sizes: L-4XL, other sizes made to order



WE DO LOGOS



MiViz offers custom letter/logo screening on all of our traffic safety wear. We can custom imprint your logo or any text you wish to display on our ANSI Outerwear.

ANSI CLASS 2-3

HIGH VALUE ANSI VESTS — ZIPPER



ANSI CLASS 2 MESH
Part# 17005-45

- 3.4 oz durable, extra breathable high visibility ANSI material
- 1 outside pocket, 1 inside pocket
- Zipper closure
- 2" silver reflective tape on front and back
- Dual Sized: L/XL, 2X/3X, 4X/5X



ANSI CLASS 3 MESH
Part# 17110-139

- 3.4 oz durable, extra breathable high visibility ANSI material with sleeves
- 1 outside pocket, 1 inside pocket
- Zipper closure
- 2" silver reflective tape on front and back
- Dual Sized: L/XL, 2X/3X, 4X/5X



ANSI CLASS 2 MESH
Part# 17005-139

- 3.4 oz durable, extra breathable high visibility ANSI material
- 1 outside pocket, 1 inside pocket
- Zipper closure
- 2" silver reflective tape on front and back
- Dual Sized: L/XL, 2X/3X, 4X/5X



ANSI CLASS 3 MESH
Part# 17110-45

- 3.4 oz durable, extra breathable high visibility ANSI material with sleeves
- 1 outside pocket, 1 inside pocket
- Zipper closure
- 2" silver reflective tape on front and back
- Dual Sized: L/XL, 2X/3X, 4X/5X



ANSI CLASS 2 MESH
Part# 16376

- 3.4 oz durable, extra breathable high visibility ANSI material
- 1 outside pocket, 1 inside pocket
- Zipper closure
- 4" orange/silver/orange reflective tape on front and back
- Dual Sized: S/M, L/XL, 2X/3X, 4X/5X

PROTECTION PRODUCTS



PREMIUM ANSI VESTS — HOOK & LOOP

ANSI CLASS 2 LIME MESH VEST

Part# 16375

- 2" silver reflective stripes
- 3.4 oz made from durable, extra breathable high visibility lime material
- Full hook and loop closure
- Sizes L-4XL



ANSI CLASS 2 ORANGE MESH VEST

Part# 16373

- 2" silver reflective stripes
- 3.4 oz made from durable, extra breathable high visibility orange material
- Full hook and loop closure
- Sizes L-4XL



ANSI CLASS 2 SOLID LIME VEST

Part# 16374

- 2" silver reflective stripes on front and back
- 3.65 oz breathable, extra durable 100% knit polyester high visibility lime material
- Matching high visibility trim all around
- Full hook and loop front closure
- Stock sizes: L-4XL, other sizes made to order



ANSI CLASS 2 SOLID ORANGE VEST

Part# 16372

- 2" silver reflective stripes on front and back
- 3.65 oz breathable, extra durable 100% knit polyester high visibility orange material
- Matching high visibility trim all around
- Full hook and loop front closure
- Stock sizes: L-4XL, other sizes made to order



**WE DO
LOGOS**



MiViz offers custom letter/logo screening on all of our traffic safety wear. We can custom imprint your logo or any text you wish to display on our ANSI Outerwear.

ANSI CLASS 2-3



ANSI CLASS 2 ORANGE MESH TEARAWAY Part# 16388

- 4" lime/silver/lime reflective tape on front and back
- 3.4 oz durable, extra breathable 100% knit polyester mesh high visibility orange material
- Matching high visibility trim all around
- Five point hook and loop tearaway (shoulders, sides, & front)
- 1 multi pencil pocket, 2 outside pouch pockets
- Stock sizes: L-4XL, other sizes made to order

ANSI CLASS 2 SOLID ORANGE TEARAWAY Part# 16389

- 4" lime/silver/lime reflective tape on front and back
- 3.65 oz breathable, extra durable 100% knit polyester high visibility orange material
- Matching high visibility trim all around
- Five point hook and loop tearaway (shoulders, sides, & front)
- 1 multi pencil pocket, 2 outside pouch pockets
- Stock sizes: L-4XL, other sizes made to order



ANSI CLASS 2 LIME MESH TEARAWAY Part# 16386

- 4" orange/silver/orange reflective tape on front & back
- 3.4 oz durable, extra breathable 100% knit polyester mesh high visibility lime material
- Matching high visibility trim all around
- Five point hook and loop tearaway (shoulders, sides, & front)
- 1 multi pencil pocket, 2 outside pouch pockets
- Stock sizes: L-4XL, other sizes made to order

ANSI CLASS 2 SOLID LIME TEARAWAY Part# 16387

- 4" orange/silver/orange reflective tape on front & back
- 3.65 oz breathable, extra durable 100% knit polyester high visibility lime material
- Matching high visibility trim all around
- Five point hook and loop tearaway (shoulders, sides, & front)
- 1 multi pencil pocket, 2 outside pouch pockets
- Stock sizes: L-4XL, other sizes made to order



ANSI MESH CLASS 3 VEST Part# 16362

- 3.4 oz durable, extra breathable high visibility orange material with 2" silver reflective stripes
- Sleeves • Full hook and loop closure
- Stock sizes: L-4XL, other sizes made to order



ANSI MESH CLASS 3 VEST Part# 16364

- 3.4 oz durable, extra breathable high visibility lime material with 2" silver reflective stripes
- Sleeves • Full hook and loop closure
- Stock sizes: L-4XL, other sizes made to order

PROTECTION PRODUCTS

ANSI CLASS E PANTS



ANSI SOLID PANTS

Part# 16328-4553 Lime

Part# 16328-45 Orange

- 3.65 oz breathable, extra durable 100% knit polyester high visibility material
- 4" contrast reflective tape
- Matching high visibility trim all around
- Side pocket slits for easy access to pant pockets
- Drawstring waist
- Hook and loop fly
- One size fits most
- When combined with an ANSI Class 2 Deluxe DOT Vest, this ensemble meets Class 3 DOT specs

ANSI LIME MESH PANTS

Part# 16367-139 Lime

Part# 16367-45 Orange

- 3.4 oz durable, extra breathable high visibility 100% knit mesh material polyester
- 4" contrast reflective tape
- Matching high visibility trim all around
- Side pocket slits for easy access to pant pockets
- Drawstring waist
- Hook and loop fly
- One size fits most
- When combined with an ANSI Class 2 Deluxe DOT Vest, this ensemble meets Class 3 DOT specs

WE DO LOGOS



MiViz offers custom letter/logo screening on all of our traffic safety wear. We can custom imprint your logo or any text you wish to display on our ANSI Outerwear.

ANSI CLASS 2-3

ANSI T-SHIRTS



ANSI CLASS 2 LIME SOLID T-SHIRT
Part# 16355-0

- ANSI Solid Polyester with Hydrowick™ technology
- 2" Silver Reflective Stripes • Chest pocket
- Lime • Sizes: M - 4X



ANSI CLASS 2 ORANGE SOLID T-SHIRT
Part# 16357-0

- ANSI Solid Polyester with Hydrowick™ technology
- 2" Silver Reflective Stripes • Chest pocket
- Orange • Sizes: M - 4X



ANSI CLASS 2 LIME MESH T-SHIRT
Part# 16355-2

- ANSI Birdseye Mesh Material
- 2" Silver Reflective Stripes • Chest pocket
- Lime 4X



ANSI CLASS 2 ORANGE MESH T-SHIRT
Part# 16357-1

- ANSI Birdseye Mesh Material
- 2" Silver Reflective Stripes • Chest pocket
- Orange • Sizes: M - 4X



ANSI CLASS 3 LIME SOLID T-SHIRT
Part# 16381-0

- ANSI Solid Polyester with Hydrowick™ technology
- 2" Silver Reflective Stripes • Long Sleeves
- Chest pocket • Lime • Sizes: M - 4X



PROTECTION PRODUCTS

FLAME RESISTANT



Gann Manufacturing
A Mutual Industries Company



**T-SHIRT
DURABLE FLAME RESISTANT
Part # 96000**

- 7.75 oz Modacrylic, Cotton, Poly blend jersey knit
- ASTM 1506 compliant
- ATPV 8.7
- NFPA 70E
- Made in USA



**ANSI CLASS 2 T-SHIRT
DURABLE FLAME RESISTANT
Part # 96001**

- 7.75 oz Modacrylic, Cotton, Poly blend jersey knit
- 2" FR silver stripes
- ASTM 1506 compliant
- ATPV 8.7
- NFPA 70E
- Made in USA



**ANSI CLASS 3 T-SHIRT
DURABLE FLAME RESISTANT
Part # 96002**

- 7.75 oz Modacrylic, Cotton, Poly blend jersey knit
- 2" FR silver stripes
- ASTM 1506 compliant
- ATPV 8.7
- NFPA 70E
- Made in USA

**FLAME
RESISTANT**

**WE DO
LOGOS**



MiViz offers custom letter/logo screening on all of our traffic safety wear. We can custom imprint your logo or any text you wish to display on our ANSI Outerwear.

FLAME RESISTANT



ANSI CLASS 2 STYLE SOLID VEST

Part # 84910 Orange
Part # 84900 Lime

NON DURABLE FLAME RESISTANT

- 100% Polyester • Meets NFPA 701
- Flame Resistant for 25 Washings • Zipper is Non Metallic (Non Conductive) • FR Reflective Silver Tape • Available in Lime and Orange



ANSI-CERTIFIED-**MESH**

ANSI CLASS 2 STYLE MESH VEST

Part # 20035 Orange
Part # 20025 Lime

NON DURABLE FLAME RESISTANT

- 100% Polyester • Meets NFPA 701 • Flame Resistant Until Washed • Zipper is Non Metallic (Non Conductive) • FR Reflective Silver Tape • Available in Lime and Orange



ANSI CLASS 2 SOLID VEST

Part # 89800 Orange
Part # 80070 Lime

DURABLE FLAME RESISTANT

- 100% Modacrylic • Meets ASTM 1506
- ATPV 5.1 • NFPA 70E • Flame Resistant for Life of Garment (Washable) • Zipper is Non Metallic (Non Conductive) • FR Reflective Silver Tape • Available in Lime and Orange



ANSI CLASS 3 SOLID VEST

Part # 80161 Orange
Part # 80061 Lime

DURABLE FLAME RESISTANT

- 100% Modacrylic • Meets ASTM 1506
- ATPV 5.1 • NFPA 70E • Flame Resistant for Life of Garment (Washable) • Zipper is Non Metallic (Non Conductive) • FR Reflective Silver Tape • Available in Lime and Orange



PROTECTION PRODUCTS

Made in USA – ANSI VESTS



Gann Manufacturing
A Mutual Industries Company



ANSI MESH CLASS 2 VEST

Part# 16468 Lime
Part# 16469 Orange

ANSI ISEA 107-2010 Compliant. Made of 3.4oz. extra breathable high visibility ANSI mesh material with sleeves. Two large pouch pockets, zipper front closure and 4" contrast reflective tape front and back. Available in sizes Med-4XL, other sizes custom made to order.



ANSI MESH CLASS 3 VEST

Part# 16491 Lime
Part# 16493 Orange

ANSI ISEA 107-2010 Compliant. Made of 3.4oz. extra breathable high visibility ANSI mesh material with sleeves. Two large pouch pockets, zipper front closure and 4" contrast reflective tape front and back. Available in sizes Med-4XL, other sizes custom made to order.

ANSI CLASS 2 SOLID DELUXE DOT

Part# 16434 Lime
Part# 16434-45 Orange

ANSI ISEA 107-2010 Compliant. New York State DOT compliant. 3.65 oz breathable, extra durable 100% knit polyester high visibility lime material. ANSI approved mesh side vents for comfort. Inside left breast pocket with 2 tiered pencil pocket. Matching high visibility trim all around zipper closure. Stock sizes: L-4XL, other sizes made to order.



CUSTOM MADE INCIDENT COMMAND VESTS

Gann offers a full line of custom made incident command vests. Each vest can be configured in custom colors, reflective stripes, pockets, clear plastic pouches and custom printing. Please call for more information and for a price quote.

WE DO LOGOS



MiViz offers custom letter/logo screening on all of our traffic safety wear. We can custom imprint your logo or any text you wish to display on our ANSI Outerwear.

CUSTOM MADE

ANY VEST, ANY STYLE, CUSTOM MADE TO YOUR SPECS!

GANN safety apparel is custom made in any style or specification you request, using the best quality materials and workmanship. Shown here are just a few of the many choices possible to meet your specific needs:



Pick Your Fabric/Color

Many Fabric Colors in Addition to Lime and Orange Are Available



Mesh



Solid



Flame Retardant



Reflective

Pick Your Style

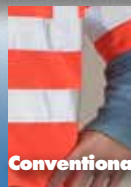

Conventional

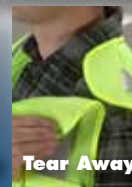

Tear Away



Adjustable

Pick Your Closure

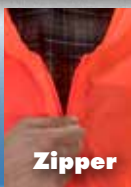

Zipper

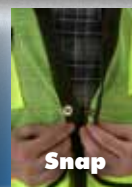

Snap

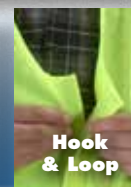

Hook & Loop

Pick Your Reflective



Silver



High Gloss

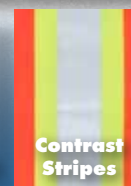

Contrast Stripes

Add Any Pocket



ID

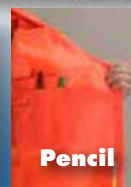

Pencil

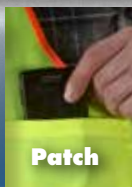

Patch

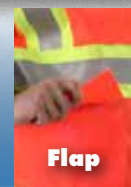

Flap

Add Logos/Lettering

Reflective Logos and Reflective Lettering Are Also Available



PROTECTION PRODUCTS

CONSTRUCTION VESTS NON ANSI



NYCT Compliant

TRANSIT AUTHORITY CONTRACTOR VEST Part# 86630

Mutual's new transit authority vest is a fluorescent orange smooth mesh ANSI/ISEA 107-2010 Class II vest featuring Reflexite universal fire rated (UFR) prismatic gloss retro-reflective material all around, with an "X" pattern on the back. The fabric meets the standard test method for flame resistance of textile ASTM D6413 as required by the NYCT.



ORANGE MESH BACK SURVEYOR VEST Part# 16302

- 1³/₈" high gloss lime/yellow reflective tape on front and back
- 3.65 oz breathable, extra durable 100% knit polyester high visibility material
- Contrasting black trim all around
- 9 various pockets
- Zipper closure
- Stock sizes: L-4XL, other sizes made to order

LIME MESH BACK SURVEYOR VEST Part# 16310-10

Same as 16302 in lime with 1³/₈" high gloss white reflective tape on front and back.

WE DO LOGOS  MiViz offers custom letter/logo screening on all of our traffic safety wear. We can custom imprint your logo or any text you wish to display on our ANSI Outerwear.

SURVEYOR



SUPER DELUXE SURVEYOR VEST

Part# 16333 Lime

Part# 16333-45 Orange

This cool mesh vest is loaded with features including an abundance of pocket room, with 4 pockets as well as a large back pocket. Snap front closure, reinforced with heavy woven poly webbing and extra visibility with both horizontal and vertical striping on front and back of vest are also featured. Available in Lime or Orange. Also available with zipper closure. Sizes: Large - 5X-Large, other sizes custom made to order.



All ANSI Vest Products Feature New Retail Packaging



Available Point Of Purchase MiViz Display



TO ORDER, CALL TOLL FREE: (800) 523-0888 or (215) 927-6000 65

PROTECTION PRODUCTS

BASIC VESTS – NON ANSI



Heavy weight safety vests are made from 7.5 oz. vinyl coated nylon mesh. A great choice where a heavier, firmer vest is desired or for colder climate areas in winter.

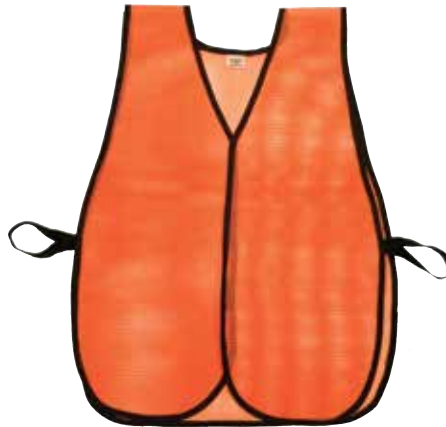

HEAVY WEIGHT SAFETY VEST-PLAIN
Part# 16301-1

Hook and Loop Closure • PVC Coated Mesh Fabric • Orange



HEAVY WEIGHT SAFETY VEST
Part# 16301-138-1375

Hook and Loop Closure • PVC Coated Mesh Fabric • HG 1³/₈" Lime Reflective • Orange

DISPOSABLE VEST
Part# 16312

10 Mil PVC in Blaze Orange. Great where an inexpensive non-reflective limited use vest is required.



WE DO LOGOS



MiViz offers custom letter/logo screening on all of our traffic safety wear. We can custom imprint your logo or any text you wish to display on our ANSI Outerwear.

SAFETY VESTS



SOFT MESH SAFETY VEST-PLAIN

Part# 16300-1

Hook and Loop Closure
• Poly Mesh Fabric • Orange



SOFT MESH SAFETY VEST-PLAIN

Part# 16304-1

Hook and Loop Closure
• Poly Mesh Fabric • Lime



SOFT MESH SAFETY VEST

Part# 16300-153-1500

Hook and Loop Closure • Poly Mesh Fabric • 1½" Lime/Silver/Lime Reflective • Orange



Soft mesh is the most popular vest material and Mutual's knit poly mesh sets the industry standard for quality and comfort.



SOFT MESH SAFETY VEST

Part# 16300-138-1000

Hook and Loop Closure • Poly Mesh Fabric • 1" Lime/Yellow Reflective • Orange



SOFT MESH SAFETY VEST

Part# 16300-53-1000

Hook and Loop Closure • Poly Mesh Fabric • 1" Silver Reflective • Orange



SOFT MESH SAFETY VEST

Part# 16304-53-1000

Hook and Loop Closure
• Poly Mesh Fabric • 1" Silver Reflective • Lime



SOFT MESH SAFETY VEST

Part# 16304-4553-1500

Hook and Loop Closure • Poly Mesh Fabric • 1½" Orange/Silver/Org Reflective • Lime





3-IN-1 ANSI CLASS 3 BOMBER JACKETS

Part# 16500-138

- Zip-out removable fleece jacket with lined sleeves
- Black accents on front and sleeve high wear areas
- PU coated waterproof polyester exterior • Hood in collar
- 2 slant pockets • 2" silver reflective tape • Soft elastic waist and wrist cuffs



ANSI CLASS 3 LIME/BLACK HOODIE

Part# 16385-138

- Drawstring Hood • Zipper Closure • Soft ANSI Fleece
- Black Accents on Front and Sleeve High Wear Areas • Slant Pockets
- 2" Silver Reflective Stripes • Hi-Viz ANSI Lime Color



This is a high quality, nominal 9oz per sq. yd. ANSI Fleece. 300g/m²

ANSI CLASS 3 LIME HOODIE Part# 16382

- Drawstring Hood • Zipper Closure • Soft ANSI Fleece
- Slant Pockets • 2" Silver Reflective Stripes • ANSI Lime Color
- Sizes available: L - 5XL

WE DO LOGOS



MiViz offers custom letter/logo screening on all of our traffic safety wear. We can custom imprint your logo or any text you wish to display on our ANSI Outerwear.

ANSI CLASS 3

ANSI CLASS 3 WINTER PARKA Part# 16370

- 2" silver reflective tape on front and back
- Heavy insulated high visibility lime mid-length coat
- Collapsible hood with drawstrings for added versatility
- Reinforced seams for strength and durability
- Sizes available: L - 4XL



ANSI CLASS 3 BOMBER JACKET

Part# 16390-45 ORANGE
Part# 16390-138 LIME

- Reflective tape: 2" Silver
- Waterproof exterior, hood in collar, and zippered pockets
- Shell: 300D polyester oxford PU coating rib cuff
- Lining: 190T polyester 10cm diamond quilt
- Sizes available: M- 5XL

ANSI CLASS 3 THREE PIECE RAIN SUIT Part# 14511

- 2" silver reflective tape on front and back
- Heavy 35mm PVC Polyester high visibility lime material
- 3-piece rainsuit consists of jacket with detachable hood, and bib overall pants
- Reinforced seams for strength and durability
- Entirely waterproof
- Comfortable, oversize fit: L - 4XL



TO ORDER, CALL TOLL FREE: (800) 523-0888 or (215) 927-6000 69

HIGH VISIBILITY ACCESSORIES



REFLECTIVE HARD HAT COVER Part# 13500

Our blaze orange mesh vest material elasticized around the edges for a secure fit to most standard hard hat styles. 1½" Lime/Silver/Lime reflective stripes added for extra visibility.



HI-VISIBILITY HARD HAT COVER Part# 50110

Mutual's bright lime hard hat cover features a high visibility lime material that fits over a standard hard hat. It has sewn elastic for secure easy placement. This hard hat cover is a perfect compliment to ANSI vest or pant ensembles.



ANSI MESH HARD HAT NECK SHADES

Part #65500-139-100 Lime w/ Reflective
Part #65500-45-100 Orange w/ Reflective

Enhance protection for outdoor workers by shielding their neck, face and ears from the sun. These lightweight ANSI Mesh Neck Shades block up to 99% of the sun's harmful UVA and UVB rays. They attach easily and securely to hard hats with an elastic edge. Available in high visibility lime with 1½" orange/silver/orange reflective stripes or in orange with lime/silver/lime reflective stripes.



ANSI HIGH VISIBILITY LIME RANGER HATS Part# 16800-145-0

- Full Brim • 360° 1½" Lime/Silver/Lime Reflective Band • Adjustable Drawstring
- Orange • Size: 1 size fits most



ANSI HIGH VISIBILITY ORANGE RANGER HATS Part# 16800-139-0

- Full Brim • 360° 1½" Orange/Silver/Orange Reflective Band • Adjustable Drawstring • Lime • Size: 1 size fits most



REFLECTIVE ELASTIC PERSONAL PROTECTION PRODUCTS Part# 14509

Be visible at night! Mutual's reflective striped neon lime/yellow belts and bands are a safety must for traffic police, firemen, EMT's, crossing guards, joggers, cyclists, security personnel, etc. Size adjusts to fit all.

Armband: 1½" x 15" with hook and loop closure
Chinstrap: ¾" x 18" adjustable. Hooks fit hard hats, bike helmets, etc.
Wristband: 1½" x 10" with hook and loop closure
Waist belt: 2" x 39" with adjustable buckle (larger size available)
Harness/suspender: 1½" x 50" adjustable. Easy side release buckle

WE DO LOGOS



MiViz offers custom letter/logo screening on all of our traffic safety wear. We can custom imprint your logo or any text you wish to display on our ANSI Outerwear.

INDUSTRIAL TOOL PRODUCTS

PALLET JACK Part# 50074

This high quality Pallet Jack is made of heavy gauge steel construction, with dropped forged fork arms that provide high strength and durability. Foot and hand controls provide easy operation. The pallet jack also features a speed lowering valve which can adjust the descent speed freely, as well as a two hundred degree steering area for added maneuverability. High quality wheels and long life lubricated bearings with dust proof caps provide trouble-free service.

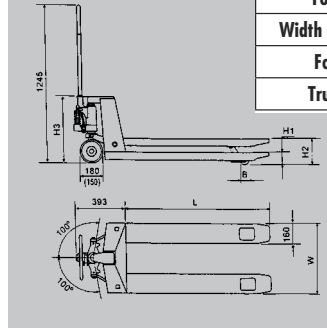

PALLET JACK SPECIFICATIONS		
Capacity	(lbs)	5500
Total lift height	H2 (in)	7 1/2"
Lowered fork height	H1 (in)	2 3/4"
Height of handles	H3 (in)	20 3/8"
Fork Length	L (in)	48"
Width over the forks	W (in)	27" 6 1/4"
Fork wheel	B (in)	3-5/8"/3" width F-B
Truck weight	(lbs)	195

MUTUAL 2-IN-1 HAND TRUCK Part# 50091

Mutual's hand truck easily converts in seconds from a conventional 2-wheeler into a platform truck. This handcart features large pneumatic tires and swivel casters with rubber wheels, and a heavy duty welded steel tubing frame for solid performance. Load capacity of 600 lbs.



LOOP HANDLE STEEL HAND TRUCK Part# 50091-79

Mutual's loop handle hand truck features a rugged tubular steel frame construction with red powder-coat finish to resist rust. Smooth-rolling, non-marking 10in. pneumatic wheels provide easy maneuvering.

Specifications: • Capacity – 700 lbs • Hand truck dimensions – 21" W x 52" H x 16" D • Toe plate dimensions – 14" W x 9" D



LONG-HANDLE SHOVEL- SQUARE TIP Part #50078-1 LONG-HANDLE SHOVEL- POINTED TIP Part #50078-2

Mutual's new shovels feature high quality 60" hardwood handles and high density steel spades for long lasting performance. Available in pointed or flat tip versions.

D-HANDLE SHOVEL- SQUARE TIP Part #50079-1 D-HANDLE SHOVEL- POINTED TIP Part #50079-2

Mutual's D-handle shovels provide maximum strength and prevent twisting with high density steel spades for long lasting performance. Available in pointed or flat tip versions.



TRAFFIC SAFETY PRODUCTS

BARRICADE PRODUCTS



GREEN SAND BAGS Part# 14981-39-14

This green 850 denier polypropylene sandbag is constructed with a 10 x 10 weave per square inch, is heat top cut, and offers 1600 hour UV protection. Sold in bales of 1000.

SAND BAGS (WOVEN POLYPROPYLENE) Part# 14981-10 White Part# 14981-45 Orange

Mutual's "circular woven" poly-propylene sandbags come complete with heavy poly-twine ties. Available in white and bright orange (1600 hr. UV protection) for increased visibility. The sandbags come in 2 sizes: 14"x 26" weighing 50 lbs. when filled, and 18"x 27" weighing 75 lbs. when filled.



HYDRANT MARKER Part# 17707

Our Top Mount Hydrant Markers are made from a high grade $\frac{3}{8}$ " x 7' fiberglass rod with built-in UV protection and heavy duty stainless steel springs. This highly visible reflective fiberglass rod easily attaches to fire hydrants to ensure that emergency crews can locate them at night or in the snow.



BARRICADES Part# 14670 Type 1 Part# 14672 Type 2

Mutual's high quality barricades are injection molded for superior strength. Available in 8" Type 1 and Type II NCHRP-350 compliant styles.



BARRICADE LIGHTS Part# 17739

Mutual's high-quality barricade lights feature a yellow 7" polycarbonate Fresnel lens with advanced optics for increased visibility. Dependable, coated solid state circuitry provides reliable operation in even the harshest weather conditions. Each light features switchable manual (ON/OFF) or automatic photosensor (which turns the light on at dusk and off at daybreak) operation. In addition, each light can be set to blink or burn steady. The high-density polyethylene case is UV stabilized to retain color and strength. Meets all MUTCD requirements and is NCHRP-350 compliant.



LED LIGHT BATONS

Part# 17755 Large **Part# 17756** Small

Mutual's Traffic Control Batons are perfect for Police and Sheriff's Department Officers, valet parking attendants, school cross walk guards, road construction crews or anyone who requires a highly visible light for traffic safety. The batons are economical to operate and are powered by bright LEDs (light emitting diodes). • Made of durable materials with slip resistant handle.

Large Baton: Noticeable 19½" total size • Orange Lens • Static or flashing with just a touch of a button • Runs on 2 D batteries (not included)

Small Baton: Compact 12" size is easy to carry • Magnetic base easily attaches to vehicles • Clear Lens • Multiple functions with a touch of a button including Flashing Red, Flashing Blue, Flashing Blue/Red Combo • Runs on 4 AA batteries (not included)



15" LIGHTSTICK Part # 17757

15" SELF ACTIVATING Part# 17756

6" lightsticks are available in: 12 hr, 8 hr, 30 min (high-intensity), 5 min (ultra-high intensity), and 15" lightsticks are available in: 12 hr, 12 hr impact (self activating), 8 hr, 8 hr impact (self activating), 5 min ultra-high intensity, and infrared. Available in Red, Green, Blue, Yellow and White.

6" LIGHTSTICK CYALUME® LIGHTSTICKS

Part# 17759

Mutual Cyalume® lightsticks are now offered in both 6" and 15" lengths and have varying intensities and durabilities so you can find a lightstick for every emergency situation. Each features a hook and loop for easy hanging from a nail, wire, or even a belt loop.



WHEEL CHOCK

Part# 14643

Mutual's wheel chocks are molded from a tough fiber-reinforced rubber compound that is well suited for tractor trailers and other heavy equipment.



UNIVERSAL TRUCKER'S SPILL KIT

Part# 17743

Reduce the cost and liability of accidental spills. Contain and absorb water and oil-based fluid spills as well as non-aggressive chemical spills. (Not designed for acids or caustics.) Helps you comply with local, state and federal D.O.T. spill regulations. Our kit easily fits in your truck cab or storage cubby. Each kit has an 8 gallon absorption capacity and contains (3) universal pads, (20) universal socks, (2) universal pads, and (2) poly bags.



DOMESTIC EPDM TARP STRAP

Part# 14979

The domestic is the finest tie-down available. Made in the USA, these tarp straps are extra thick and strong to meet the requirement of even the most demanding tie-down user. These straps feature rounded tear drop ends with 2½" "S" hooks pre-inserted. Available in 10", 15", 21", 31" and 41" lengths. 50 per box.

EMERGENCY TRIANGLE

Part# 50095

Mutual's Emergency Triangle Kits are manufactured with an outer border of red high-intensity retro-reflective plastic and an orange fluorescent plastic inner triangle. Supplied in sets of 3 with compact case for storage. Meets or exceeds Federal Specification FMVSS-125.

TRAFFIC SAFETY PRODUCTS

TRAFFIC CONES



TRAFFIC CONES

- Part# 17720** 18" Orange – 3lb
- Part# 17721** 28" Orange – 7lb
- Part# 17723** 36" Orange – 10lb
- Part# 17716** 18" Lime – 3lb
- Part# 17717** 28" Lime – 7lb
- Part# 17718** 36" Lime – 10lb

Mutual's new traffic cones are one of the most durable on the market today. They feature a softer base, and very competitive pricing. Available in 18" #3, 28" #7, 28" #10, and 36" #10 sizes. Available with or without reflector.

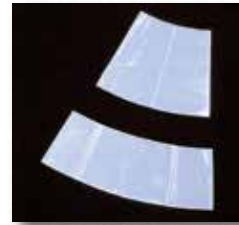

CONE COLLARS

Part# 17741

This 2-piece non-adhesive set includes one 4" and one 6" white high-gloss, conical reflective sheeting with 450 (cd/lx/sm). Also available for slim-line cone styles.

RETRACTABLE CONE BAR

- Part# 17727** 4' - 8' Yellow/Black Reflective
- Part# 17727-45-10** 6' - 10' Orange/Yellow Reflective

Used in combination with Mutual's traffic cones, these cone bars form an instant barrier. Highly portable and versatile, Mutual's cone bars expand and retract from 3' to 6' as needed.



TRAFFIC DELINEATORS

- Part# 17725-12** 48" Reflective N Top w/Base
- Part# 17735-12** 48" Reflective D Top w/Base

Highly visible and UV resistant to fading. Offering high resistance to impact over a wide temperature range. Each weighted PVC base is made entirely of 100% recyclable PVC.

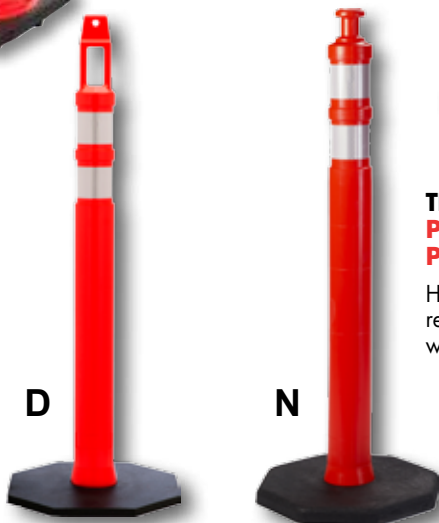

CONES



Collapsed Cone in Included Carry Case

Collapsible Traffic Cones

Perfect for emergency responders, Fire/EMS or simply as an emergency kit for motorists. Meets MUTCD Standards. Constructed of orange waterproof nylon • Internal light has 2 settings: steady burn and flashing • Cone light endures 100,000 flashes or 36 hours of steady burn • Usable temperature is -40F to 130F. Available in 18" and 28" sizes

28" DELUXE LIME

Part# 17712-1-28 1 Pack

Part# 17712-5-28 5 Pack

28" DELUXE ORANGE

Part# 17714-1-28 1 Pack

Part# 17714-2-28 2 Pack

Part# 17714-5-28 5 Pack

18" DELUXE LIME

Part# 17712-1-18 1 Pack

Part# 17712-4-18 5 Pack

18" DELUXE ORANGE

Part# 17714-1-18 1 Pack

Part# 17714-4-18 4 Pack



LED light included inside cones provide light for low visibility conditions

Collapsible Traffic Cones with Rubber Base

Same as above, but with heavy-duty rubber bases that resist moving from high winds or passing cars and trucks.

28" DELUXE WITH

RUBBER BASE ORANGE

Part# 17731-0-28 1 Pack

Part# 17731-3-28 3 Pack

• 10" x 10" • 4.5lbs

18" DELUXE WITH

RUBBER BASE ORANGE

Part# 17731-0-28 1 Pack

• 15" x 15" • 7lbs



Collapsed Cone in Included Carry Case

TRAFFIC CONE SIGNS

Part# 17729 13" x 11"

Traffic cone signs are supplemental standard warnings and directions that create a safer work environment, and have been shown by the Federal Highway Administration to improve safety and reduce liability. Specially cut grooves allow the signs to install and in seconds and lock firmly in place. All weather UV resistant construction maintains their high-visibility color. In addition to use on traffic cones, these durable, reusable signs can also be used on traffic barrels and traffic delineators.



TRAFFIC SAFETY PRODUCTS

FLAG & BANNER PRODUCTS



ABS STOP/SLOW PADDLE W/STAFF
Part# 14655

Mutual's durable ABS Stop/Slow paddles have an 81" high staff for easy handling and are highly visible to motorists on the road. These paddles come in two sizes (18" or 26"), and four different reflective grades (non-reflective, engineer grade reflective, high intensity reflective, or ABS diamond grade). Each 18" paddle has 6" lettering, while the 26" paddle has 8" lettering. All paddles have a two piece, 2" x 81" tall white plastic handle.



STOP/SLOW PADDLE
Part# 14983

18" diameter traffic control paddles are available lettered with "STOP" on one side and "SLOW" on the other side. Large 6" letters in the official traffic sign colors with shapes make Mutual's paddles easily identifiable by motorists. Made of lightweight non-corrosive and weather-proof material with no sharp edges, Mutual's paddles are safe and long lasting. They are available with 10", 5', or 6' handles.



AIRPORT FLAG WO/STAFF
Part# 14977
AIRPORT FLAG W/STAFF
Part# 14977-5

A heavy nylon 36" x 36" flag made of alternating 12" x 12" orange and white squares. Heavy-duty stitching and reinforced pocket make for easy mounting. Required by FAA and OSHA for all construction equipment and contractor vehicles in airports.



ROAD SIGN COVERS
Part# 17713

No more trash bags and duct tape needed with Mutual Industries new sign cover. Made from our durable WF200 woven polypropylene material. Top edges are sewn and it attaches to any in seconds with hook and loop strap system. Available in the following sizes:

Size	Fits
50" X 50"	Standard 48" X 48" Sign
38" X 38"	36" X 36" Sign
62" X 38"	Trailblazer Sign 36' X 60"
64" X 38"	Extended Trailblazer 36" X 62"



BREEZE SENSITIVE WINDSOCK AND KIT
Part# 14950

Mutual Industries windsocks are made of urethane-coated nylon and react to the slightest wind movement. Complete kits include the windsock, ties, round aluminum inlet frame, 30" metal pole, and brackets to mount the pole onto a flat metal surface. Inlet Diameter: 18", Outlet Diameter: 13¼", Length: 96"

SNOW POLES

Snow Pole Driveway Markers

Mutual's Snow Pole Driveway Markers are a perfect way to keep you on the road when winter's snow starts to hide where your driveway ends. Highly visible, these durable, easy to set up markers provide the quickest way to identify driveways, culverts, hazardous areas and private roadways in the worst conditions.

- 48" high, durable ¼" diameter orange fiberglass rod
- Designed to be highly visible from all angles
- Top features a protective rubber tip, bottom is pointed for easy installation

Part# 14657-0-0

- **48" HIGH VISIBILITY FIBERGLASS ROD**
(Box of 100)



Part# 14657-153-0

- **48" HIGH VISIBILITY FIBERGLASS ROD WITH 360° SILVER REFLECTIVE**
(Box of 100)



Part# 14657-0-1

- **48" HIGH VISIBILITY HEAVY DUTY 3/8" DIAMETER FIBERGLASS ROD WITH FLAG**
(Box of 100)



DOUBLE-SIDED LOAD BANNERS

Part# 14990-141

Mutual's load banners measure 18" x 7' and have heavy-duty grommets, as well as rope ties sewn in. They are made of a super-tough, 12 oz yellow vinyl-coated nylon material and have bold black letters which say "Wide Load" on one side and "Oversized Load" on the other.

TRAFFIC SAFETY PRODUCTS

FLAG & BANNER PRODUCTS

RED POLYETHYLENE SAFETY FLAGS

Part# 14961-12

12" x 12"

Mutual's red polyethylene safety flags are a quick and easy, highly visible warning. These inexpensive flags are perfect for lumber yards, home improvement centers, and many other uses. They are made from a tear-resistant polyethylene and come in 12" x 12" sheets. 100 per pack.



TEAR OFF DANGER FLAGS

Part# 14667

Mutual's convenient disposable danger flags are heavy, 4-mil, polyethylene flags are 12" x 12" x 300' Plain and DANGER (1500 per roll) or 16" x 16" x 300' Plain and DANGER (1200 per roll). They easily tear off at the perforations and are suited for use in lumber yards.



HEAVY-DUTY OPEN MESH TAILGATE FLAGS

Part# 14969

These flags are ideal for use on moving vehicles. Their open mesh design allows air flow and will not fray. They are fluorescent, red/orange, and are hemmed and grommeted along the top. They come with or without a dowel spreader and are available in 12" x 12", or 18" x 18". 10 per bundle.



HEAVY-DUTY TAILGATE FLAGS

Part# 14986

These durable, 3-ply, fluorescent red/orange, vinyl coated nylon tailgate flags are hemmed and come with a wire stay with a loop in the center for convenient application. Available in 18"x18". Sold in case quantity of 100 pieces.



CLOTH SIGNAL FLAGS **Part# 14966**

Mutual's red or green cloth signal flags are great for rail yards and construction equipment. Sizes available: 18" x 18" x 24", and 24" x 24" x 36". 10 per bundle.



SAFETY FLAGS



NO-FOUL HIGHWAY SAFETY FLAGS

Part# 14965

Mutual's vinyl coated nylon safety flag with a no-foul batten sewn in. Sizes available: 18" x 18" with 27" staff.



REFLECTIVE HIGHWAY SAFETY FLAGS

Part# 14962

Heavy-duty vinyl coated nylon safety flag with a yellow reflective stripe for extra nighttime visibility. Available in 18" x 18" with 27" staff and 24" x 24" with 36" staff.



**Flags Sold
10 per
Bundle**



RED HIGHWAY SAFETY FLAGS

Part# 14967-79

LIME HIGHWAY SAFETY FLAGS

Part# 14994-139

As required by certain D.O.T.'s, Mutual's standard highway safety flag in a solid red.

STANDARD HIGHWAY SAFETY FLAGS

Part# 14994

Mutual manufactures an orange heavy-duty vinyl coated nylon safety flag that is ideal for roadside construction signs and for directing traffic.



Standard and Open Mesh flags are available in:

- 12" x 12" with 24" staff
- 18" x 18" with 24" staff
- 18" x 18" with 27" staff
- 24" x 24" with 30" staff
- 24" x 24" with 36" staff

HEAVY-DUTY OPEN MESH SAFETY FLAGS

Part# 14975 Part# 14968 BLACK TRIM

Mutual's heavy-duty vinyl coated open weave nylon mesh safety flag is well suited for all construction and traffic applications. This flag is ideal for use on moving vehicles. Its open mesh design allows air flow and will not fray. Mutual's heavy-duty open mesh flag with a black binding offers excellent contrast for better visibility as well as additional fraying protection on the already non-fraying material.

HARD HATS

PROTECTION PRODUCTS



Hard Hats

Meets ANSI Z89.1-2009, Type 1 Class E.G.C Pin Lock & Ratchet

With a tough polyethylene shell, Mutual's hard hats are strong, lightweight, and durable. Each hard hat features a four-point adjustable nylon suspension for shock absorbing protection. Reinforced ribs on top provide additional impact protection. Each hard hat has slotted sides to accommodate accessories such as face shields or ear muffs, and is available in white, blue, green, yellow, orange and red.



4-POINT PIN LOCK SUSPENSION HARD HAT

- Part# 50100-10 - White
- Part# 50100-25 - Blue
- Part# 50100-39 - Green
- Part# 50100-41 - Yellow
- Part# 50100-45 - Orange
- Part# 50100-79 - Red



4-POINT RATCHET SUSPENSION HARD HAT

- Part# 50200-10 - White
- Part# 50200-25 - Blue
- Part# 50200-39 - Green
- Part# 50200-41 - Yellow
- Part# 50200-45 - Orange
- Part# 50200-79 - Red



6-POINT RATCHET SUSPENSION HARD HAT

- Part# 50215-79 - Red
- Part# 50215-39 - Green
- Part# 50215-41 - Yellow
- Part# 50215-10 - White
- Part# 50215-45 - Orange
- Part# 50215-25 - Blue



6-POINT RATCHET SUSPENSION HARD HAT, HIGH VISIBILITY

- Part# 50215-139 - Lime
- Part# 50215-145 - Orange



FULL BRIM HARD HAT WITH RATCHET SUSPENSION

- Part# 50210
- Full brim provides protection from UV rays on ears and back of neck. Comfortable adjustable ratchet suspension provides a secure fit. Available in red, green, yellow, blue, white and orange.

HARD HATS



OTT7
Part# 65600

Knitted over the top 2-ply heavy band liner fits over the brim of the hard hat to prevent wind tunneling.

OTT9
Part# 62100

Knitted over the top full-face style 2-ply heavy band liner fits over the brim of the hard hat to prevent wind tunneling.



PLASTIC FACE SHIELD
Part# 50511

BRACKET FOR HARD HAT
Part# 50512

Bracket for Hard Hat and 8" x 15½" aluminum bound PC clear visor. EN166 and ANSI Z87.1 compliance.

FACE SHIELD W/ VISOR
Part# 50510

Mutual's ABS brow guard protects against forehead injury, and comes complete with 8" x 15½" aluminum bound PC clear visor. EN166 and ANSI Z87.1 compliance.



ANSI MESH HARD HAT NECK SHADES

Part #65500-139-100 Lime w/ Reflective
Part #65500-45-100 Orange w/ Reflective

Enhance protection for outdoor workers by shielding their neck, face and ears from the sun. These lightweight ANSI Mesh Neck Shades block up to 99% of the sun's harmful UVA and UVB rays. They attach easily and securely to hard hats with and elastic edge. Available in high visibility lime with 1½" orange/silver/orange reflective stripes or in orange with lime/silver/lime reflective stripes.



ANSI HARD HAT COVER
Part# 50110

Mutual's bright lime hard hat cover features a high visibility lime material that fits over a standard hard hat. It has sewn elastic for secure easy placement. This ANSI hard hat cover is a perfect compliment to ANSI vest or pant ensembles.



REFLECTIVE HARD HAT COVER
Part# 13500

Our blaze orange mesh vest material elasticized around the edges for a secure fit to most standard hard hat styles. 1½" Lime/Silver/Lime reflective stripes added for extra visibility.



HARD HAT MOUNTED EAR MUFFS
Part# 50501

Deep ear cups with large foam filled cushions have durable steel head bands and easily snap on and off hard hats. SNR: 23db and NRR: 22db rated for hearing protection. EN352-1, ANSI S3.19



Gann Manufacturing
A Mutual Industries Company

Three loop straps with adjustable Velcro closure.

REGULAR NAPE



Non Durable vs Durable Flame Resistant What's the Difference?

Non Durable Flame Resistant is flame resistant until washed. Durable Flame Resistant is flame resistant that stays flame resistant after it's washed.



LOOPER
Part# 55900

8oz. 100% Canton Flannel. Flame retardant shell with a soft naped interior



OSG
Part# 10044

8oz. 100% Canton Flannel. Flame retardant shell with a soft naped interior. Features specialty top ties instead of the side velcro.



Q-VEL
Part# 67900

Nylon tricot shell (treated with flame retardant), quilted with foam. Soft fleece lining.



Q-VEL NV
Part# 67500

Nylon tricot shell (treated with flame retardant), quilted with foam. Soft fleece lining.



Q-STRAP
Part# 66800

Nylon tricot shell (treated with flame retardant), quilted with foam. Soft fleece lining.



REDVEL
Part# 68800

Twill shell with red fleece lining.



27 PB
Part# 72000

Twill shell with soft flannel lining.



30 BOMBER
Part# 68900

Twill shell with sherpa lining.



FS-1 DURABLE FLAME RETARDANT
Part# 68500

Durable flame resistant outer shell with 100% cotton flannel lining. Meets ATSM F1506.

WINTER LINERS

Long nape for added protection and 3 loop straps with adjustable Velcro closure.

LONG NAPE



SUPER II
Part# 60000

100% cotton twill shell (treated with flame retardant) with sherpa lining. LONG NAPE.



SUPER II WH
Part# 60600

100% cotton twill shell (treated with flame retardant) with sherpa lining. LONG NAPE.



SUPER 3M
Part# 64200

100% cotton twill shell (treated with flame retardant) with soft fleece lining and 3M Thinsulate insulation. LONG NAPE.



SUPER Q
Part#60300

Same styling as the #59800 Super but made with nylon tricot shell (treated with flame retardant), quilted with foam and a soft fleece lining. LONG NAPE.



FS-2
DURABLE FLAME RETARDANT
Part# 63700

Durable flame resistant outer shell with 100% cotton flannel lining. LONG NAPE.
Meets ATSM F1506.



FS-2 MP
DURABLE FLAME RETARDANT
Part# 63800

Durable flame resistant outer shell with 100% cotton flannel lining with protective mouth piece. LONG NAPE.
Meets ATSM F1506.



WINTER LINERS

PROTECTION PRODUCTS



Gann Manufacturing
A Mutual Industries Company

Extra long nape and 3 loop straps with adjustable Velcro closure at neck.

EXTRA LONG NAPE



MINIARCTIC
Part# 72100

100% cotton twill shell, treated with flame retardant. Heavy sherpa lining.



28 CAPE
Part# 72200

Twill 4 panel construction with soft fleece lining.



28 CAPE MP
Part# 80400

Twill 4 panel construction with soft fleece lining with protective mouth piece.



28 3M THINSULATE
Part# 61700

100% cotton twill shell, treated with flame retardant. Heavy sherpa lining.



28 3M MP THINSULATE
Part# 71300

100% cotton twill shell, treated with flame retardant. Heavy sherpa lining with protective mouth piece.



FS-3 DURABLE FLAME RETARDANT
Part# 71700

Durable flame resistant outer shell with 100% cotton flannel lining.
Meets ATSM F1506.

SPECIALTY



GASAFEOR
Part# 70100-100

Orange Banox® Durable Flame Retardant exterior (stays Flame Retardant after being washed) with a flame retardant flannel liner. EXTRA LONG NAPE.
Meets ATSM F1506.



44 TUNDRA
Part# 72700

Twill cap (flame retardant) with fleece lining. The zip-off heavy knitted dickie has a two button closure at the throat. The two pieces attach with a plastic molded zipper. Features three loop straps and slots to fit a 4-point suspension. EXTRA LONG NAPE.

WINTER LINERS



PAINTER'S DUST HOOD

Part# 13910

100% Cotton twill hood w/ large clear plastic insert for optimal visual benefits. Approximately 12" finished length.



40 LINESMAN

Part# 63500

"Linesman" style with soft FR fleece or flannel lining. Three loop straps, mouth piece and chin protector. LONG NAPE.



40 LINESMAN NV

Part# 10042

"Linesman" style with soft FR fleece or flannel lining. Three loop straps, mouth piece and chin protector. LONG NAPE.



42 ZIPPERHEAD

Part# 72600

Twill cap with zip-off twill nape protector. Three loop straps with adjustable Velcro closure.



42 ZIPPERHEAD NV

Part# 72XXX

Twill cap with zip-off twill nape protector. Three loop straps with adjustable Velcro closure.



REFLECTIVE WINTER LINER

SUPERVIZ

Part# 60097

Stay safe with this highly visible reflective winter liner! 100% cotton twill navy blue shell (treated with flame retardant) with soft red fleece lining. 2" reflective runs vertically along the back. Short nape style.



WINTER LINERS

PROTECTION PRODUCTS



OTT7
Part# 65600 Navy

OTT7RD
Part# 66200 Red

OTT7OR
Part# 66100 Orange

OTT7WL
Part# 65900 Navy Wool



Knitted over the top, 2-ply heavy band liner fits over the brim of the hard hat to prevent wind tunneling. Available in Navy, Red and Orange.



OTT9
Part# 62100 Navy

OTT9WLRD
Part# 71000 Red Wool



OTT9OR
Part# 62200 Orange

Knitted over the top full-face style 2-ply heavy band liner fits over the brim of the hard hat to prevent wind tunneling. Available in Navy, Red and Orange.



WOOL

GASKIMASK3W
Part# 38700

Knitted full-face style 100% heavy wool mask that keeps your head, face and neck warm.



WOOL

GASKIMASK1W
Part# 38600

Knitted full over the head style 100% heavy wool mask that keeps your head and neck warm.



WOOL

GASKICAPW
Part# 38800

Knitted 100% heavy wool ski cap that keeps your head warm.



**MEETS
ASTM
F1506**

**DURABLE
FLAME
RETARDANT**

GANOMXBK
Part# 20015-100

Black knit Nomex® Durable Flame Retardant winter liner (stays Flame Retardant after washing). Wraparound button closure keeps the front of your neck warm.

Meets ATSM F1506.



**FIRE
RETARDANT**

GAFF6GN
Part# 74900-100

Green knit Non Durable Flame Retardant winter liner. Wraparound button closure keeps the front of your neck warm.

WINTER LINERS



High quality Winter Liners feature velcro fasteners-dielectric with no metal, and three suspension tabs. One universal size. Made in U.S.A.



REGULAR NAPE



WL3-45



WL3-250



WL3-210



WL3338

LONG NAPE



WL4-45



WL4-250



WL4-210



WL4338



TO ORDER, CALL TOLL FREE: (800) 523-0888 or (215) 927-6000 87



Colorful new patterns join our market-tested favorites. ALL-COTTON balloon top, rugged double stitch construction and absorbent cotton sweat band. Comfortable. Durable. Washable. Meticulously constructed and individually inspected in America, as are all of our caps, by skilled union craftsmen. Individually sized 6 ⁷/₈ through 7 ⁷/₈ . Made in U.S.A.

STYLE A



A52



A32A



A32B



A32G



A32V



A250



A45



A70



A75



A210



SIGNATURE

SGA250

Black washable cotton embroidered Signature Cap. Sizes 6 ⁷/₈ through 7 ⁷/₈.

KROMER CAPS



A252



A298



A336



A338



A339



A340



A346



A348



A349



A350



A352



A355



A357



A358



A360



A361



A362



A532



A751

TO ORDER, CALL TOLL FREE: (800) 523-0888 or (215) 927-6000 89

BEANIES & WELDING SAFETY ACCESSORIES

PROTECTION PRODUCTS



Flame Retardant* Made to fit snugly to protect from dust or shop dirt these caps are suited for a variety of indoor and outdoor work situations. They are not only Flame Retardant* treated but retain the Kromer tradition of comfort as well. Available in sizes M, L, and XL. Made in U.S.A. *Non-durable



STYLE SK



SK357



SK336



SK52



SK338



SK250



SK210



WELDING CAP (BEANIE)

Part# 57500

Made of non-durable flame resistant navy twill.



WELDING VISOR

Part# 50068

- Welding goggle with polycarbonate lens
- Vinyl frame features a positive-action, flip-front IR shade 5 filter lens
- Hooded vents allow air to circulate
- Meets the requirements of ANSI Z87.1



COMMERCIAL/INDUSTRIAL BURN KIT

Part# 50005

Take care of burns in any emergency situation with Mutual Industries Burn Kit. Each kit contains "Burnfree" gel and sterile dressings that immediately begins to soothe and cool the skin, helping to prevent burns from progressing. In addition, Mutual's gel helps minor burns, cuts, scrapes and abrasions from getting infected. Unlike other first aid burn gels, Mutual's contains no lidocaine or benzocaine which can cause an allergic reaction.



KROMER CAPS

These premium Made in U.S.A. caps with soft floppy visors are fully washable and can be crushed or rolled up and stuffed in your pocket. Individually sized 6 ⁷/₈ through 7 ⁷/₈.

STYLE K



K338



K32A



K32B



K250



K210



K336



K357

STYLE BK



BK751



BK75

THE RAILROADER

One size fits all. This washable cotton pleated top cap is available with adjustable strap for sizes 6 ⁷/₈ through 7 ⁵/₈. Made in U.S.A.



COTTON WRAPS Part# 50300

Classic head covering has a super absorbent terrycloth band to keep sweat out of your eyes and off your face. Available in Chilli Peppers, American Flag, and Paisley Red.



CELLULOSE SWEATBAND

Part# 50355

This disposable sweatband provides cool relief under hard hats, welding helmets, and sandblast hoods. Dip the sweatband in cold water, squeeze out and wear. This band will wick away perspiration while allowing cooling evaporation to take place. It will stay soft, and has an elastic band box stitched to the material for durability.

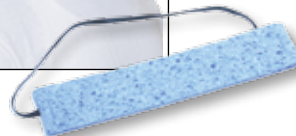



.35MM PVC/POLYESTER 3 PIECE SUIT
Part# 14505

- 3-Piece Rainsuit Consists of a 32" Jacket with Detachable Hood, and Bib Overall Pants
- Reinforced Seams for Strength and Durability
- Made from 100% Non-Conductive Material
- Entirely Waterproof
- Comfortable, Oversized Fit, Size: SM - 5XL

ANSI CLASS 3
THREE PIECE RAIN SUIT
Part#14511

- Heavy 35mm PVC/Polyester High Visibility Lime Material.
- 3-Piece Rainsuit Consists of Jacket with Detachable Hood, and Bib Overall Pants.
- 2" Silver Reflective Tape on Front and Back.
 - Reinforced Seams for Strength and Durability.
 - Entirely Waterproof.
- Comfortable, Oversized Fit, Size: L - 5XL



.35 MM PVC/POLYESTER
RAINCOAT W/DETACHABLE HOOD
Part#14506

- 2-Piece Raincoat Consists of a Full Length 49" Raincoat with Detachable Hood.
- Reinforced Seams for Strength and Durability
- Made from 100% Non-Conductive Material
- Entirely Waterproof
- Comfortable, Oversized Fit, Size: SM - 4XL



17" SLUSH BOOT

Part# 14500

- Extra Wide, 17" High Over-the-Shoe Slush Boots
- Available in High-Visibility Yellow or in all Black
- Comfortable Fit Over Work Shoes
- Sizes 8-18



16" PVC WHITE SOCK BOOT WHITE BOOT PLAIN TOE

Part# 14504-1

WHITE BOOT "STEEL TOE"

Part# 14504-2

Mutual's White PVC boots feature the same quality construction and upper as Mutual's Black PVC over the sock boots. Mutual's White Boots are designed for red meat processing, poultry processing, packing plants, commercial fishing and shrimping, and other food processing applications. Both are available in plain and steel reinforced toe in men's full sizes 6-13.



5 BUCKLE ARCTIC BOOT

Part# 14501

- 14" High Over-the-Shoe 5-Buckle Arctic Boots
- Self-Draining Gussets
- Comes in Black with a Maroon Sole
- Sizes 9-16



16" PVC BLACK SOCK BOOT BLACK BOOT PLAIN TOE

Part# 14502-1

BLACK BOOT "STEEL TOE"

Part# 14502-2

Mutual's PVC Injection molded boots are 100% waterproof and are ergonomically designed for maximum comfort. These boots feature a seamless molded construction that uses two different compounds to provide an extra soft upper, with a long wearing, slip resistant sole. Mutual's PVC Boots have a mildew resistant liner and are reinforced at critical points. Choose Mutual's Black boot for all of your construction, concrete, landscaping and agricultural needs. Available in both plain toe and steel reinforced toe in men's full sizes 6-13.



MANTARAY SAFETY GLASSES

Part# 49900 Clear
49901 Grey
49902 Amber
49903 Mirror

Sleek, sporty style with one piece lens design and adjustable fit. Meets ANSI Z87.1 and AS/NZS 1337



DOLPHINS SAFETY GLASSES

Part# 50082 Clear
50083 Amber
50084 Grey
50085 Rainbow Mirror

Black matte finished frame with enlarged optical lenses, lightweight adjustable arms. Meets the requirements of ANSI Z87.1 and AS/NZS 1337
 Sold by the dozen.



SNAPPERS SAFETY GLASSES

Part# 50056 Clear
50057 Grey
50058 Amber
50059 Rainbow Mirror

- Ultra-cool and ultra-lightweight polycarbonate frames ensure worker acceptance
- Wraparound design fits snugly for total optical protection
- Features a 9.75 base spherical polycarbonate lens and 99% UV protection
- Meets the requirements of ANSI Z87.1 and AS/NZS 1337
- Sold by the dozen.



WRAP-AROUND SAFETY GLASSES

Part# 50030 Clear
50031 Grey
50027 Amber

The Wrap-Around style safety glasses offer sharp clarity with vented reinforced side shields, and full brow guard at an economical price. The nose-bridge design is universal, thus a standard fit for all. Meets ANSI Z87.1-1989 standards for OSHA compliance. Sold by the dozen.



PERFORATED SAFETY GOGGLES

Part# 50041

CHEM/SPLASH SAFETY GOGGLES

Part# 50040

Mutual's Safety Goggles feature tough polycarbonate lenses that provide superior protection against nuisance dust, flying particles, and liquid splash. Mutual's Safety Goggles are available in two styles, perforated for impact applications, and chem/splash for liquid/ impact applications. Sold by the dozen.



SAFETY GLASSES

GATORS

Part# 50086 Clear
50087 Grey
50088 Amber
50089 Rainbow Mirror

- Complete adjustability for a perfect fit
- 12-position ratchet mechanism and 5-position temple arm length adjustment
- Frame-less design makes this eyewear choice exceptionally lightweight
- Contemporary, polycarbonate lens
- Optically correct lens is anti-scratch coated and offers 99% UV protection
- Meets the requirements of ANSI Z87.1
- Sold by the dozen.



Arms Pivot



SHARK GLASSES

Part# 50064 Clear
50065 Grey
50066 Rainbow Mirror
50067 Amber

Mutual Shark protective glasses have a single panoramic lens design and offer superior frontal and peripheral protection. The Shark offers ultimate hazard protection with a full range of view and 7-base curve design. Meets or exceeds all ANSI safety standards including Z87.1-1989. Sold by the dozen.



MARLIN GLASSES

Part# 50036 Blk Frame Clear
50035 Blk Frame Grey
50050 Blk Frame Mirror
50051 Blk Frame Amber
50034 USA Frame Clear
50037 USA Frame Grey
 Mutual Marlin protective glasses pack full protection in a lightweight product, an amazing 1 oz. design. It has an integral lens construction with an adjustable side arm. The plastic wide angle brow plate provides overhead protection. Meets all ANSI standards. Sold by the dozen.

CLEAR	Maximum visual acuity and maximum color recognition
AMBER	Provides increased sharpness, visual acuity and contrast
GRAY/MIRRORED	Reduces brightness and glare while allowing excellent color recognition

LENS CLEANING TOWELETTE DISPENSER

Part# 50042

Enhance the performance of your eye glasses, safety glasses, and goggles by keeping them clean and clear with Mutual's Lens Cleaning Towelette Dispenser. The pre-moistened lens cleaning towelette's anti-fog, anti-static formula can be safely applied to plastic, glass, polycarbonate lenses, face shields and goggles, and contains no silicone. The dispenser comes completely assembled and ready for use, featuring a convenient pull out bottom and built in tab for hanging. Each dispenser contains 100 individually foil-wrapped 5" x 8" towelettes. Sold by the dozen.





WEATHERPROOF FIRST AID KITS

Part# 50001 - 10 person kit

Part# 50002 - 25 person kit

Part# 50003 - 50 person kit

Be ready for situations that require quick medical treatment with a first aid kit from Mutual Industries. Designed to meet your specific requirements, Mutual Industries First Aid Kits come in 10, 25, and 50 person sizes. Each easy-to-use kit is packaged in a practical weatherproof (gasketed) polypropylene case for added durability and assists in complying with OSHA requirements.



25 PERSON METAL FIRST AID KIT

Part# 50006

Mutual now offers its 25 person first aid kit in a 20 gauge steel case. It features a cover that opens to 90° to form a working shelf when the kit is in use. Custom printing is also available.

Each kit contains:

- Adhesive Strips
- Large Wound Pad (25 & 50 only)
- Eye Pads
- Triangular Bandages
- First Aid/Burn Cream (25 & 50 only)
- Eye Flush (50 only)
- Elastic Bandages
- Scissors
- Forceps
- First Aid Instructions
- Gauze Pads
- Gauze Bandages
- Adhesive Tape
- Antiseptic Towelettes
- Aspirin
- Cold Pack
- Latex Exam Gloves

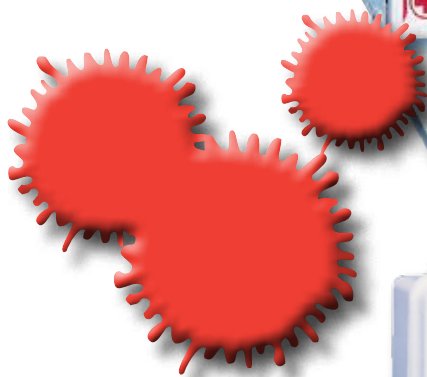

BLOODBORNE PATHOGENS PROTECTION KIT

Part# 50004

Protect yourself and your employees with a Bloodborne Pathogens Kit from Mutual Industries. Each kit provides the necessary clean up and protection products to meet the bloodborne pathogen standards, packaged in a weatherproof case designed specifically for the industrial market.

Each kit contains:

Personal Protection Apparel:

- Control Gown
- Eye & FaceShield/Mask
- Latex Exam Gloves

Clean-Up Provisions

- Absorbent Powder
- Scoop & Spatula
- Biohazard Bag
- Unmarked Bag
- Disinfectant Cloth
- Antiseptic Towelettes



COMMERCIAL/INDUSTRIAL BURN KIT

Part# 50005

Take care of burns in any emergency situation with Mutual Industries Burn Kit. Each kit contains "Burnfree" gel and sterile dressings that immediately begins to soothe and cool the skin, helping to prevent burns from progressing. In addition, Mutual's gel helps minor burns, cuts, scrapes and abrasions from getting infected. Unlike other first aid burn gels, Mutual's contains no lidocaine or benzocaine which can cause an allergic reaction.

Each kit contains:

- 4" x 4" Dressings
- "Burnfree" Gel
- Unit Dose Gel Packets
- Roller Gauze



16 OZ. DOUBLE EYE WASH STATION

Part# 50013

Part# 50012 Refill

Mutual's double eye wash station features 2-16 oz. bottles for safety and convenience.



32 OZ. EYE WASH STATION

Part# 50010 Station

Part# 50011 Refill

Take the first step in protecting your employees from eye injury with Mutual's 32 oz Sterile Isotonic Buffered Eye Wash Station. This convenient station can be mounted on a wall and contains a large (32oz) bottle of eye solution that will work to neutralize the effects of acids & alkalis, while flushing away other chemicals, foreign particles or irritants from the eye. Refills are also available.



N95 DUST/MIST RESPIRATOR

Part# 50015

Part# 50015-1 With Valve

Our single use N95 Respirator has a 95% filter efficiency level. It is effective against particulate aerosols free of oil; time use restrictions may apply. These lightweight, contour fit respirators are maintenance free, have 2 elastic straps for a comfortable efficient fit and allow easy breathing and speaking while in use. Packaged 20 per box (12 boxes per case).

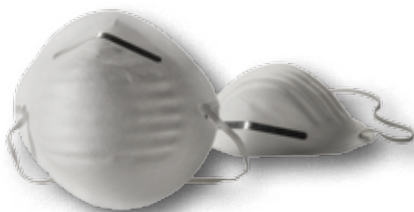

NUISANCE DUST MASK

Part# 50048

Mutual's nuisance mask provides relief against non-toxic dust irritants and other nuisance level particles in the workplace. These economical, high-quality masks are packaged 50 per box (20 boxes per case).

HEARING PROTECTION, COVERALLS, MAINTENANCE



DISPOSABLE COVERALL

Part# 13900

- Storm fly front with seal
- Full cut for comfort and fit
- Non-sparking zipper
- Meet or exceed ANSI/ISEA 101-1993
- SEI certified, Size: M to 4XL 25 per case

DISPOSABLE BUNNY SUIT

Part# 13905

- Storm fly front with seal
- Attached hood with elastic face
- Elastic wrist & oversized shoe covers
- Full cut for comfort and fit
- Non-sparking zipper
- Meet or exceed ANSI/ISEA 101-1993
- SEI certified, Size: M to 4XL 25 per case

INDUSTRIAL FLOOR SIGNS

Part# 14663

Molded of durable polyethylene, Mutual's industrial floor signs are made to withstand considerable use. These signs are the double faced easel type and fold flat for easy storage. Permanently hot stamped with a bilingual message. Available with same message both sides: CAUTION WET FLOOR (ENGLISH/SPANISH)



CORRUGATED PLASTIC FLOOR SIGNS	
LEGEND	COLOR
Side 1 - Danger Asbestos Side 2 - Potential Asbestos Hazard Area	Red & Black on White
Side 1 - Caution Wet Floor Side 2 - Caution Slippery When Wet	Black on Yellow
Side 1 - Caution Do Not Enter Side 2 - Caution Keep Out	Black on Yellow
Side 1 - Caution Men Working Side 2 - Caution Hazardous Area	Black on Yellow
Side 1 - Caution Wet Paint Side 2 - Caution Watch Your Step	Black on Yellow
Side 1 - Caution Men Working Above Side 2 - Caution Men Working Below	Black on Yellow
Side 1 - Caution Wet Floor/Bilingual (Spanish) Side 2 - Watch Your Step/Bilingual (Spanish)	Black on Yellow
Side 1 - Keep Clear Restrooms out of Service Side 2 - Keep Clear No Entrance	Black on Yellow



CORRUGATED PLASTIC FLOOR SIGNS

Part# 19669

These inexpensive floor stands help alert people to hazardous areas. These 12" x 20" floor stands are printed with a different legend on each side, inside and out, for multiple usage. They fold flat for easy storage and are reusable.

PROTECTION PRODUCTS



PAINTER'S DUST HOOD

Part# 13910

100% cotton twill hood w/large clear plastic insert for optimal visual benefits. Approximately 12" finished length



EAR MUFFS

Part# 50024

Mutual's new comfortable, adjustable fit ear muffs are SNR: 25db and NRR: 22db rated for hearing protection.



HARD HAT MOUNTED EAR MUFFS

Part# 50501

Deep ear cups with large foam filled cushions have durable steel head bands and easily snap on and off hard hats. SNR: 23db and NRR: 22db rated for hearing protection. EN352-1, ANSI S3.19



PURA-FIT EAR PLUGS-UNCORDED

Part# 50020

- Decibel rating: NRR 31 • Tapered fit
 - Non irritating • Brightly colored
 - Cord is secure & cleanly attached
 - Hygienically packaged in individual pouches
 - 1 pair per pouch • 200 pair per dispenser box
 - 10 dispenser boxes per case
- Total 2000 pairs |



SPARKPLUG PLUGS-UNCORDED

Part# 50022

- Decibel rating: NRR 31 • Extra soft, low pressure foam
 - Tapered end for easy insertion
 - Shapes to fit even the smallest ear canals
 - Available in fun colors • 1 pair per pouch
 - 200 pair per dispenser box
 - 10 dispenser boxes per case
- Total 2000 pairs per case



PURA-FIT EAR PLUGS-CORDED

Part# 50021

- 1 pair per pouch • 100 pair per dispenser box
 - 20 dispenser boxes per case
- Total 2000 pairs per case



SPARKPLUG PLUGS-CORDED

Part# 50023

- 1 pair per pouch • 100 pair per dispenser box
 - 20 dispenser boxes per case
- Total 2000 pairs per case





SURE GRIP GLOVES

Part #50072-3 Large
Part #50072-4 Extra Large

Grip Gloves are unique gloves that are economical and highly effective in many work situations. Each glove forms to the hand as its worn, enabling workers to retain excellent dexterity and touch. Sure Grip Gloves are 10-gauge string knit with latex-coated palm and fingers, which is liquid resistant as well. Sold by the dozen.

HEAVY DUTY LEATHER PALM WORK GLOVES

Part# 50071

Mutual's work gloves feature a gun pattern, rubberized safety cuff, wing thumb, split leather palm and finger tips, elastic strap, knuckle strap and a cotton padded lining. 2½" Rubberized Safety Cuff. Sold by the dozen.



COLD WEATHER FOAM/LATEX GLOVE

Part# 50069

Thermal, 7-Gauge, High Visibility Green Terry Shell, Brushed Acrylic/Polyester Interior, Black Foam Latex Palm Coating, Sizes: S-XL



LATEX UTILITY GLOVES

Part# 28000

Industrial grade all purpose 5 mil latex gloves offer superior strength, fit and comfort. Lightly powdered. Also available in powder free. Sizes: Sm, Med, Lg and XL. 100 per box/ 10 boxes per case.



27000 VINYL GLOVES

Part# 27000

These gloves give you a better fit, increased sensitivity and reduces risk of pinholes. USP dusting powder prevents irritation and allows for an easier fit. Sizes: Sm, Med and Lg. 100 per box, 10 boxes per case.



BLUE HIGH-RISK LATEX GLOVES (14MIL)

Part# 29000

Mutual's high risk glove offers maximum protection in hazardous situations. These gloves provide extra length and extra protection-14 mil fingers, 12 mil palm, 10 mil cuff and 12" length. Used by EMT's, ER, police, labs and in industrial applications where a better quality latex glove is required. Powder Free. Sizes Sm, Med, Lg, and XL. 50 per box/10 boxes per case.



KNEE PADS

Part# 50525

Abrasion resistant plastic with soft comfortable foam padding provides protection against impacts, bruises and abrasions. These durable, quality knee pads are lightweight and available in LG, and XL sizes.



ECONOMY KNEE PAD

Part# 50526

Mutual's economy knee pads provide protection without all the cost. These pads are made of comfortable, durable foam with an elastic band for a tight fit. One size fits all.

SUPPORTS



Measure Waist Size	
Size	Waist
SM	27"-32"
MD	32"-37"
LG	37"-42"
XL	42"-47"
2X	47"-52"



9" VENTILATED INDUSTRIAL SUPPORT Part# 10-10080

- 9" Wide back support • Helps reduce back stress and injuries while encouraging proper body mechanics
- Reduces risk of back injury for people engaged in heavy lifting • For use by men and women • 4 Stays to prevent rolling up of support • Adjustable elastic suspenders for comfort and support • Tapered front panels for comfort while bending
- Washable • Color: Black only



ADJUSTABLE NEOPRENE ELBOW SUPPORT Part# 10-75000

- Retains body heat and increases circulation
- Provides compression and support for confident play • Features universal sizing: fits either left or right elbow • Adjustable hook & loop fasteners. Individually packaged in clamshell • Color: Black
- Size: Adjustable, one size fits all



ADJUSTABLE NEOPRENE WRIST/ TENNIS ELBOW SUPPORT Part# 10-75140

- Retains body heat and increases circulation
- Provides compression and support for confident play • Features universal sizing: fits either left or right wrist/forearm



ADJUSTABLE NEOPRENE THIGH SUPPORT Part# 10-75600

- Retains body heat and increases circulation
- Provides compression and support for confident play • Features universal sizing: fits either left or right thigh • Adjustable hook & loop fasteners. Individually packaged in clamshell • Color: Black
- Size: Adjustable, one size fits all



ADJUSTABLE NEOPRENE ANKLE SUPPORT Part# 10-75100

- Retains body heat and increases circulation
- Provides compression and support for confident play • Features universal sizing: fits either left or right ankle • Adjustable hook & loop fasteners. Individually packaged in clamshell • Color: Black
- Size: Adjustable, one size fits all



ADJUSTABLE NEOPRENE OPEN PATELLA Part# 10-75420

- Retains body heat and increases circulation
- Provides compression and support for confident play • Features universal sizing: fits either left or right knee • Reinforced padded patella located at knee cap adds support without applying direct pressure on patella



ADJUSTABLE NEOPRENE KNEE STABILIZER W/STRAPS Part# 10-75520

- Retains body heat and increases circulation
- Provides compression and support for confident play • Features universal sizing: fits either left or right knee • Customer fitting dart design closure system • Metal stays provide lateral support • Reinforced padded patella • Extra dual straps with hook & loop fasteners for additional compression

TO ORDER, CALL TOLL FREE: (800) 523-0888 or (215) 927-6000 101

FIBER FORM TUBES

Part# 7065

Lightweight and easy to handle, fiber form tubes are for one time applications that reduce the cost of pouring footings, round columns and piers. Each tube is made from a heavy duty cardboard form designed to replace labor intensive wood forms.

SIZE	DESCRIPTION
6"x 12'	Economy
8"x 12'	Economy
10"x 12'	Economy
12"x 12'	Regular
14"x 12'	Regular
16"x 12'	Regular
18"x 12'	Regular
20"x 12'	Regular
22"x 12'	Regular
24"x 12'	Regular
30"x 12'	Regular
36"x 12'	Regular
10" x 48"	Economy
12" x 48"	Economy



BLAST SAND

BLAST SAND & BACKER RODS

BLAST SAND

Part# 900

Available in a variety of precise grain sizes for epoxy floors, cement and asphalt applications. Quality control program assures consistent and repeatable grain sizes. Packaged in 50 and 100 lb. bags. Also available in bulk, dump truck, super sacks and tri-axle loads.

SIZE	DESCRIPTION
0	100# Blast Sand 30/Pt
00	100# Blast Sand 30/Pt
00N	100# Blast Sand 30/Pt
000	100# Blast Sand 30/Pt
1	100# Blast Sand 30/Pt
2	100# Blast Sand 30/Pt



High Purity blast sand features consistent physical properties and uniformity of product within precise gradations.

STANDARD BACKER ROD

An ideal non-absorbent compressible backup material inserted into a joint to control sealant depth, create a backstop to allow proper sealant tooling, allows proper sealant of the joint surfaces, yields a proper bond between the back-up material and the sealant. It can also be used as a temporary joint seal.

SIZE	LF/Bx	DESCRIPTION
¼"	4,000	Standard Backer Rod
⅜"	2,100	Standard Backer Rod
½"	2,500	Standard Backer Rod
⅝"	1,550	Standard Backer Rod
¾"	1,100	Standard Backer Rod
⅞"	850	Standard Backer Rod
1"	600	Standard Backer Rod



TO ORDER, CALL TOLL FREE: (800) 523-0888 or (215) 927-6000 103

SIZE	DESCRIPTION
GALV ANCHOR BOLTS & IMPORTS	
1/2"X6"	Anchor Bolts
1/2"X8"	Anchor Bolts
1/2"X10"	Anchor Bolts
1/2"X12"	Anchor Bolts
1/2"X14"	Anchor Bolts
1/2"X16"	Anchor Bolts
1/2"X18"	Anchor Bolts
FOUNDATION ANCHORS	
14 3/4"	28 Ga Wall Ties
22 3/4"	28 Ga Wall Ties

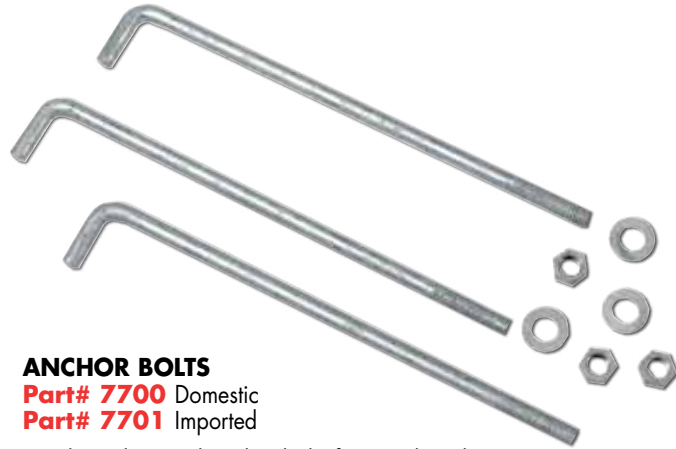

ANCHOR BOLTS

Part# 7700 Domestic
Part# 7701 Imported

Hot dip galvanized anchor bolts for attaching bottom or sill plates to foundations. These bolts are ideal for use with treated lumber and provide reliable holding strength.

TIE WIRE - BLACK ANNEALED

Part# 2260

Black annealed, and galvanized annealed (which is used for added corrosion protection) are both available in 16 Gauge. Packaged with 20 3 1/2# coils to a 70 lb. carton, our standard pallet contains 27 cartons.

BAR TIES - BLACK ANNEALED

Part# 2265-6

Used to secure rebar to rod chairs and other intersecting pieces of rebar. Available in 4", 6" & 8", 5000/bag 16 ga

TWISTING TOOLS - HAND TYING TOOL (MANUAL)

Part# 2265

The original tying tool. Speed, ease of use, and economy make this tool one of our best sellers.



TIE WIRE & BAR TIES

SIZE	DESCRIPTION
3.5#	Tie Wire 16Ga 20/Cs
6"	16Ga Bar Ties 1M/5M
8"	16Ga Bar Ties 1M/5M

CORRUGATED WALL TIES

Part#7100

Used for anchoring masonry to masonry. Gauges: Available in #22, #26 Ga., Available in Mill Galv. Dimensions: Standard size is 7/8" wide x 7" long Other widths, lengths and gauges available upon special request.



SIZE	LF/Bx	DESCRIPTION
7/8" X 6 3/8"	500	26 Ga. Wall Ties
7/8" X 6 3/8"	500	26 Ga. Wall Ties
7/8" X 6 3/8"	1,000	28 Ga. Wall Ties
7/8" X 6 3/8"	500	22 Ga. Wall Ties
7/8" X 6 3/8"	100	22 Ga. Wall Ties

NAIL STAKES

NAIL STAKES

Part# 7500

Primarily used to secure wood or metal forms to the ground in all flatwork applications. Additionally, they are commonly used for attaching screed bar holder clamps in flatwork finishing, securing landscape timbers, surveying stakes, string line guides, securing metal forms with pockets and securing wood forming for flatwork



NAIL STAKES

3/4"
18 X 3/4"
24 X 3/4"
30 X 3/4"
36 X 3/4"
42 X 3/4"
7/8"
18 X 7/8"
24 X 7/8"
30 X 7/8"
36 X 7/8"

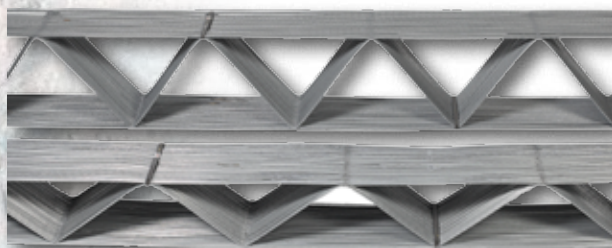

WALL TRUSS

Part# 2100

Wall trusses provide joint reinforcement for superior performance of masonry wall construction. They reduce cracking that can arise from thermal stresses, enhance resistance to water penetration, increase lateral strength and bond masonry at intersecting walls and corners. Available in #4, #6, #8, #10 and #12

MILL GALV WALL TRUSS

SIZE	BUNDLE
#4	500' /Bdl
#6	500' /Bdl
#8	500' /Bdl
#10	500' /Bdl
#12	500' /Bdl

ROD CHAIRS

Part# 88041 2"

Part# 88042 3"

Fast, convenient and easy to use. Rod chairs hold rebar and wire mesh off grade in foundations.

ROD CHAIRS
2" Rod Chair 100/Bx
3" Rod Chair 100/Bx

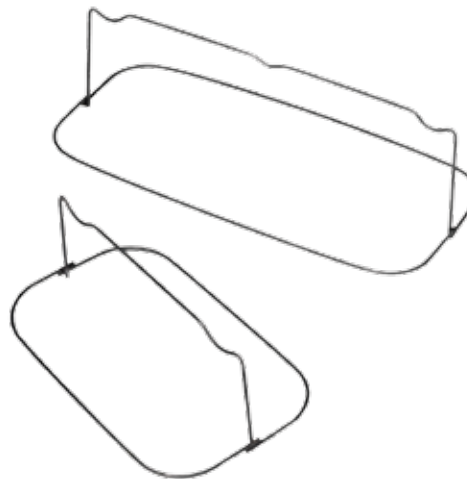

TO ORDER, CALL TOLL FREE: (800) 523-0888 or (215) 927-6000 105

COLUMNS	
MODEL	DESCRIPTION
	4" ADJUSTABLE COLUMN
960	6' To 6'4" Adj Column
963	6'3" To 6'7" Adj Column
966	6'6" To 6'10" Adj Column
969	6'9" To 7'1" Adj Column
970	7' To 7'4" Adj Column
973	7'3" To 7'7" Adj Column
976	7'6" To 7'10" Adj Column
979	7'9" To 8'1" Adj Column
980	8' To 8'4" Adj Column
983	8'3" To 8'7" Adj Column
986	8'6" To 8'10" Adj Column
989	8'9" To 9'1" Adj Column
990	9' To 9'4" Adj Column
993	9'3" To 9'7" Adj Column
996	9'6" To 9'10" Adj Column
999	9'9" To 10'1" Adj Column
9100	10" To 10'4" Adj Column
CODE	4" CONCRETE COLUMN
80200020	5' Concrete Filled Column
80200001	6' Concrete Filled Column
80200002	6'6" Concrete Filled Column
80200003	6'8" Concrete Filled Column
80200004	7' Concrete Filled Column
80200005	7'6" Concrete Filled Column
80200006	8' Concrete Filled Column
802007	8'6" Concrete Filled Column
80200010	10' Concrete Filled Column
80200012	12' Concrete Filled Column

ADJUSTABLE COLUMNS Part# 700

Complies with IRC and IBC, Completely assembled, 4" x 8" plate welded to top end and 3½" x 6" plate permanently attached to screw on bottom end. Flow-coated inside and out with red corrosion-resistant paint, Straps available upon request, Different sizes available upon special request



CONCRETE COLUMNS Part# 2000

Each Column consists of 16 Ga Tubular steel. Filled with concrete. Columns are available in 4" width and available from 5' to 12' lengths. BOCA National Building Code/1999 approved.





BASEMENT WINDOWS
32 x 14 Vinyl Window
32 x 18 Vinyl Window
32 x 22 Vinyl Window

BASEMENT WINDOWS
Part# 7130

Maintenance Free, All Vinyl Construction. Fusion Welded Header and Jambs on Frame with a Mechanically Fastened, Fully Weather-stripped, Cam Locking Handle. Full Screen included, each Window is individually boxed.

ANGLE IRON
Part# 7300

Designed to carry loads over an opening such as a door or window. Painted 3" x 4" x 1/4" steel. See chart for available sizes.



ANGLE IRON
3' 6" Angle Iron Painted
4' Angle Iron Painted
4'6" Angle Iron Painted
5' Angle Iron Painted
5'6" Angle Iron Painted
6' Angle Iron Painted
7' Angle Iron Painted
8' Angle Iron Painted
8'6" Angle Iron Painted
10' Angle Iron Painted
20' Angle Iron Painted

WINDOW ACCESSORIES
Part# 3230

Stucco Tape - Stucco/EIFS masking applications are usually accomplished with a tape constructed of a UV resistant film and adhesive system. These tapes are often applied directly to window and door frames.

Window Film - Surface protection products typically carry low to moderate tack adhesives to ensure no residue upon removal. These products are used for temporary protection on glass and other durable, solid surfaces.

Pallet Wrap - high performance hand wrap designed to securely unitize irregularly shaped and difficult to wrap loads. Manufactured of a quality three layers, cast, co extruded, linear low-density polyethylene film with both side cling.

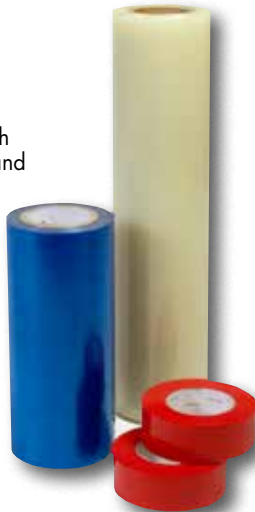

SIZE	WINDOW ACCESSORIES
21" X 600'	Window Shield Clear 30 TO 45 Days
24" X 600'	Window Shield Blue 30 TO 45 Days
	Polyethylene Tape 24 per case

SUMPS AND FITTINGS

Part# 1524

These products are made from heavy duty polyethylene are lightweight, corrosion proof, as well as acid, alkali and frost resistant.



SUMPS & LIDS	
PART #	DESCRIPTION
SUMPS	
1524	Sump Pit
1530	Sump Pit
LIDS	
1537AD	HD Sump Lid 5/Bag
1537ADL	Locking Sump Lid 5/Bag
1537AD	Radon Vented Lid 1/Bag

FITTINGS		
PART #	SIZE	DESCRIPTION
3" FITTINGS		
312AA	24/Bag	3" External Coupler Snap Type
315AA	50/Bag	3" Internal Coupler Snap Type
321AA	12/Bag	3" Single Wall Snap Tee
332AA	30/Bag	3" Snap End Cap
322AA	7/Bag	3" Single Wall 45 Deg Wye
390AA	12/Bag	3' Single Wall 90 Deg Elbow
3" & 4" FITTINGS		
412AA	24/Bag	4" External Coupler Snap Type
417AA	16/Bag	3" Internal Coupler Snap Type
421AA	8/Bag	4" Single Wall Snap Tee
432AA	40/Bag	4" Snap End Cap
422AA	5/Bag	4" Single Wall 45 Deg Wye
490AA	10/Bag	4' Single Wall 90 Deg Elbow
445AA	15/Bag	4' Single Wall 45 Deg Elbow
6" FITTINGS		
612AA	8/Bag	6" External Coupler Snap Type
615AA	9/Bag	6" Internal Coupler Snap Type
626AA	3/Bag	6" Single Wall Snap Tee
631AA	12/Bag	6" Snap End Cap Split Type
622AA	2/Bag	6" Single Wall 45 Deg Wye

DOWNSPOUT ADAPTERS	
PART #	DESCRIPTION
364AA	2 X 3 X 3 Downspout Adapter
464AA	2 X 3 X 4 Downspout Adapter
465AA	3 X 4 X 4 Downspout Adapter

DRAINAGE PIPE



SINGLE WALL DRAINAGE PIPE

Part# 92

Single wall corrugated HDPE pipe is ideal for drainage projects where flexibility, light weight and low cost are important.

Perforated and non-perforated plastic drainage pipe is used for subsurface water collection or leaching action. ADS corrugated HDPE pipe is offered with uniform slots and drilled holes. Non-perforated pipe is available when water must be moved by gravity flow from one point to another.

DRAINAGE PIPE	
SIZE	DESCRIPTION
3" X 100'	Perforated Pipe
3" X 100'	Solid Pipe
3" X 300'	Perforated Pipe
3" X 300'	Solid Pipe
4" X 100'	Perforated Pipe
4" X 100'	Solid Pipe
4" X 250'	Perforated Pipe
4" X 250'	Solid Pipe
6" X 100'	Perforated Pipe
6" X 100'	Solid Pipe



FRAME & GRATE

Part# 3500

Heavy duty cast iron frame and grate. Excellent for catch basins in parking lots and gutter inlets.
12" X 12", 18" X 18" & 24" X 24"



BELL TRAPS

Part# 3000

These durable cast Iron traps feature a spigot and lid.

BELL TRAPS
6 x 6 CI Bell Traps
9 x 9 CI Bell Traps
12 x 12 CI Bell Traps
66S Bell Trap Strainer Only
99S Bell Trap Strainer Only
1212S Bell Trap Strainer Only



LATH & ACCESSORIES
2.5 Flat Lath
METAL
#1-A Exp Flange Corner Bead
#66 Exp Flange Casing Bead 1/2"
#66 Exp Flange Casing Bead 3/4"
#15 Double V Exp Jt 1/2"
#15 Double V Exp Jt 3/4"
VINYL
#1 Vinyl Corner Bead 10'
Vinyl Casing Bead 1/2" 100/Bx
Vinyl Casing Bead 1/2" 100/Bx
1/2" Vinyl Exp Jt 10'
3/4" Vinyl Exp Jt 10'
1" Vinyl PV Start Strip W/Drp 1/16"
1.5 Vinyl PV Start Strip W/Drp 1/16"

CASING BEAD

Part# 7220

Casing bead is used as a plaster stop, screed ground, as exposed trim around doors and windows and as a base screed. Available in galvanized steel and zinc alloy, 10 ft. lengths, 30 pieces, 300 feet per carton. The expanded flange width is 3 inches.

CORNER BEAD

Part# 7210

This is the standard accessory for providing exterior corner protection and providing a reliably straight ground for screeding. The 3" expanded mesh wings are easily flexed to adapt to framing irregularities and to match appropriate screed heights. Furnished in galvanized steel and zinc (99% pure zinc) alloy. Weight per 1000 lineal feet, galvanized, 185 lbs.; zinc weight, 160 lbs.

EXPANSION JOINT

Part# 7230

Designed to provide for movement to accommodate expansion and contraction caused by initial stucco shrinkage and minor thermal movement. Produced in galvanized steel and zinc alloy in 10' lengths.



METAL LATH

Part# 7201

Manufactured from prime quality steel sheets that are slit and expanded to form small diamond shaped openings (over 10,000 per square yard). This large number of openings provides more plaster keys than any other type of lathing material. This allows for better stucco bonding in either pumped or troweled applications.



WIRE MESH

Part# 2250

6" X 6"-10GA WELDED WIRE MESH ROLLS & SHEETS

ROLLS - WELDED WIRE MESH ROLLS used in concrete construction. 5' X 150' 10 Ga. Rolls

SHEETS - Welded Wire Mesh sheets used in concrete construction. 5' X 10' 10 Ga. sheets, sold in bundles of 100 sheets.

FIREPLACES

FIRE BRICK

Fire brick is a low-duty brick used in the construction of residential fireplaces and in light industrial applications. Our split fire brick line the interior of wood burning stoves. Fire brick and split fire brick are available in buff and red colors and in a variety of sizes to meet specific applications.

FIRE CLAY

Fire clay is used when building ovens or fireplaces with firebrick.

FIREBRICK		
PART #	COLOR	DESCRIPTION
13261001	Buff	8¼"x4x2½" BUFF FIRE BR
13261002	Red	8¼"x4x2½" BUFF FIRE BR
13222001	Buff	8¼"x4x1¼" BUFF FIRE BR
13222002	Red	8¼"x4x1¼" BUFF FIRE BR
15461001	Buff	9"x4½"x2½" BUFF FIRE BR
15461002	Red	9"x4½"x2½" BUFF FIRE BR
15422001	Buff	9"x4½"x1¼" BUFF FIRE BR
15422002	Red	9"x4½"x1¼" BUFF FIRE BR
60070500		50# FIRE CLAY 40/Pt

FLUE RINGS	
INSIDE DIAMETER	LENGTH'S AVAILABLE
6"	6", 9", 12", 15", 18"
7"	6", 9", 12", 15", 18"
8"	6", 9", 12", 15", 18"
9"	6", 9", 12", 15", 18"
10"	6", 9", 12", 15", 18"
12"	6", 9", 12", 15", 18"

FLUE LINERS

8½ X 8½ Flue Liner 84/Pt

8½ X 13 Flue Liner 60/Pt

13 X 13 Flue Liner 40/Pt

8½ X 18 Flue Liner 36/Pt

12 X 16 Flue Liner

13 X 18 Flue Liner 24/Pt

16 X 16 Flue Liner 18/Pt

18 X 18 Flue Liner 18/Pt

16 X 20 Flue Liner 19/Pt

20 X 20 Flue Liner 18/Pt

20 X 24 Flue liner 18/Pt

24 X 24 Flue liner 12/Pt

ROUND LINERS

6" Round Flue Liners 24"

7" Round Flue Liners 24"

8" Round Flue Liners 24"

10" Round Flue Liners 24"

12" Round Flue Liners 24"

FLUE LINERS AND RINGS

A clay chimney flue liner is the safest, most efficient product designed to carry away the byproducts of fireplaces and many gas appliances. The inert nature of clay makes the final product resistant to rust and corrosion caused by the by-products of combustion in the furnace.

The smooth surface inside the clay flue liner resists creosote build-up caused by low-burning fires. However, all chimneys still need to be periodically inspected and cleaned.

Unlike metal, clay is a slow conductor of heat, further minimizing the danger of heating masonry and wood structures surrounding the lining.





REFRACTORY CEMENT Part# 600

Dry-mix refractory mortars are made from high temperature cements and carefully selected aggregates that will not expand or tear the mortar apart when heated. Once dried, these products are non-water soluble and more acid resistant than any other type of product used in these applications. 50 lb and 100lb bags are available.



REFRACTORY CEMENT	
PART #	DESCRIPTION
60060600	15# HEAT STOP WET 120/PT
60070600	50# HEAT STOP WET 36/PT
60090700	10# HEAT STOP DRY 120/PT
60070700	50 HEAT STOP DRY 36/PT

TOP SEALING DAMPER Part# 2000

The Energy Saving Damper is proven to reduce air loss through the chimney by as much as 90%. Traditional chimney dampers are known to be inefficient and are costing you hundreds of dollars every year. The Damper mounts easily atop a flue tile with silicone cement, which is included. A 32' stainless steel cable, handle and bracket, which are also included, drop down the flue.

DAMPER
DESCRIPTION
TOP SELLING DAMPERS
8 x 8 Top Sealing Damper
9 x 13 Top Sealing Damper
13 x 13 Top Sealing Damper
13 x 18 Top Sealing Damper
17 x 17 Top Sealing Damper
12" Round Top Sealing Damper
40' Cable
50' Cable
HP Hardware Pack

Damper, Poker & Rotary Control Damper

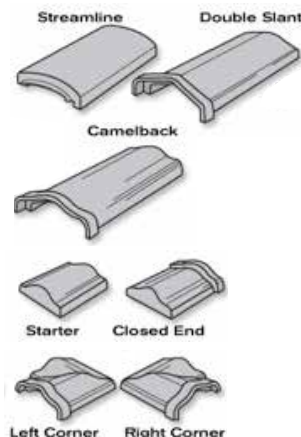

COPING	
9" Camel Back Coping 2' Pc	
9" Corners Left	
9" Corners Right	
9" Starter	
9" Ender	
9" Streamline Coping 2' Pc	
9" Corners Left	
9" Corners Right	
9" Starter	
9" Ender	
13" Camel Back Coping 2' Pc	
13" Corners Left	
13" Corners Right	
13" Starter	
13" Ender	
13" Streamline Coping 2' Pc	
13" Corners Left	
13" Corners Right	
13" Starter	
13" Ender	

CAST IRON DAMPER	
PART #	DESCRIPTION
DAMPERS & ACCESSORIES	
1001	24" Poker Damper
1002	30" Poker Damper
1003	33" Poker Damper
1004	36" Poker Damper
1005	42" Poker Damper
1001	48" Poker Damper
2007	54" Poker Damper
2008	60" Poker Damper
2009	72" Poker Damper
MULTI-OPENING DAMPERS	
8001	3016 Multi-Opening Damper
8002	3320 Multi-Opening Damper
8003	3620 Multi-Opening Damper
8004	4220 Multi-Opening Damper
8005	4824 Multi-Opening Damper
ACCESSORIES	
15001	R-1 Rotary Control 24" Thru 54"
15002	R-2 Rotary Control 60" Thru 72"
15003	P-3 Poker Control 24" Thru 54"
15004	P-4 Poker Control 60" Thru 72"

FIREPLACES

FIREBOX DOORS

Part# 260

Replace rusted or broken clean out doors with cast iron doors for easy access to your chimney. These clean out doors are hinged with single-bolt closures, and work for both indoor or outdoor clean outs.



FIRE BOXES

Part# 5000

The firebox is a critical component of every fireplace chimney and ensuring that it is up to proper standard is important to making your chimney as safe as it can be. The firebox is a two walled structure inside of your chimney, which contains the direct heat of the fire and guides the products of combustion towards the smoke chamber and the flue.

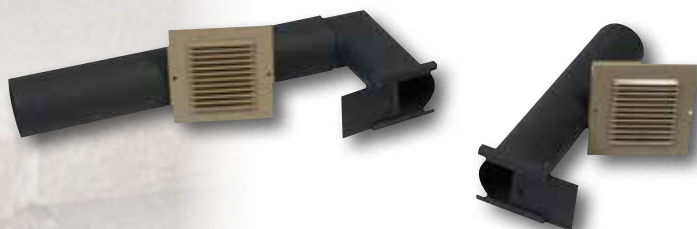

FIREPLACE ACCESSORIES

8 x 8 CI Clean Out Door

10 x 8 CI Clean Out Door

12 x 8 CI Clean Out Door

12 x 10 CI Clean Out Door

12 x 12 CI Clean Out Door

16 x 12 CI Clean Out Door

8 x 8 Steel Clean Out Door

D0-12 Dutch Oven Door

AC Ash Caddy

FIRE BOXES & ACCESSORIES

30 Firebox Fireplace

34 Firebox Fireplace

38 Firebox Fireplace

42 Firebox Fireplace

50 Firebox Fireplace

FANS & GRILLES

#9 Grilles ans Housing 4/Bx

F-9 Fans 2/Bx

F-10 Fans 2/Bx

OUTSIDE AIR KITS

OA Outside Airkits

MOKR Rear Outside Airkit

MOK Side Outside Airkit

ANGLE IRON
3' 6" Angle Iron Painted
4' Angle Iron Painted
4' 6" Angle Iron Painted
5' Angle Iron Painted
5' 6" Angle Iron Painted
6' Angle Iron Painted
7' Angle Iron Painted
8' Angle Iron Painted
8' 6" Angle Iron Painted
10' Angle Iron Painted
20' Angle Iron Painted

ANGLE IRON

Part# 7300

Designed to carry loads over an opening such as a door or window. Painted 3" x 4" x 1/4" steel angle. See chart for available sizes.



CHIMNEY CAPS	
PART #	DESCRIPTION
STAINLESS STEEL	
99-0-0	SS Chimney Cap
913-0-0	SS Chimney Cap
918-0-0	SS Chimney Cap
1313-0-0	SS Chimney Cap
SS-1318	SS Chimney Cap
1818-0-0	SS Chimney Cap
98-0-0	SS Leg Kit
GALVANIZED PAINTED BLACK	
99-91	PTD Chimney Cap
912-91	PTD Chimney Cap
918-91-0	PTD Chimney Cap
1313-91-0	PTD Chimney Cap
1318-91-0	PTD Chimney Cap
1818-91-0	PTD Chimney Cap



Stainless Steel

Lifetime Warranty, 100% Stainless Steel, 24 Gauge Single Piece Stainless Steel Hood with Roll Formed Edges, 16 Gauge Stainless Steel Base for Extra Strength, 18 Gauge 3/4" Expanded Stainless Steel Mesh.

Galvanized Painted Black

Seven-Year Warranty, 24 Gauge Single Piece Galvanized Steel Hood, 14 Gauge Galvanized Steel Base for Extra Strength, 18 Gauge 3/4" Expanded Stainless Steel Mesh, 18 Gauge, Attractive Black Powder Coated Paint.

TERMS & CONDITIONS

MINIMUM ORDER: All products are combinable for pricing discounts. The dollar amount of your total order is used to determine individual product pricing. \$300.00 minimum initial order is required to open a net 30 day account. Minimum \$100.00 order for established accounts. All orders less than \$100.00 are subject to a service fee as follows:
Orders between \$99.00 – \$50.00 are assessed a \$10.00 service fee.
Orders \$49.00 or less are assessed a \$15.00 service fee.

CUSTOM PRODUCTS: On special orders, Mutual reserves the right to ship and invoice $\pm 10\%$ of the ordered quantity. CUSTOM PRODUCTS ARE NOT RETURNABLE.

PAYMENT TERMS: Invoice in full within thirty (30) days, subject to prior approval by Mutual of buyers credit. No CODs. VISA and MASTERCARD accepted. Amounts unpaid after thirty (30) days shall bear interest at the rate of 1% per month. Prices and specifications are subject to change by Mutual without notice to buyer. Mutual's prices do not include Federal, State, or local sales, use, excise, or similar taxes. Buyer shall provide Mutual with a tax exemption certificate acceptable to the taxing authorities. No deductions on invoices will be accepted without prior approval from a Mutual Industries Customer Support Representative. Discrepancies must be reported in a timely manner to one of our internal Customer Support Representatives at 800-523-0888 prior to remittance of invoice. Any deductions taken without prior approval will not be honored.

RETURN POLICY: No returns shall be accepted by Mutual without a return authorization number. All products must be returned within ten (10) days of receipt of authorization number. Unauthorized returns will be refused. Authorization will not be given for items purchased over six (6) months previous. Buyer is responsible for all return freight and a 20% restocking charge. NO RETURNS shall be accepted by Mutual on custom manufactured products.

FACTORY FREIGHT POLICY: A 5% freight allowance is given on orders of \$4000.00* or more. Alaska, Hawaii, and Canada, a 5% freight allowance will be credited on invoice. All shipments are F.O.B. shipping point. Title and risk of loss for all products shall pass to buyer on delivery by Mutual to a common carrier regardless of the freight terms stated or method of payment for transportation charges. On orders less than \$4000.00 and shipped by common carrier, freight will be collect unless verbally requested otherwise. UPS shipments will be prepaid and added to the invoice. Mutual reserves the right to choose a common carrier on a prepaid order.

LOST/DAMAGED SHIPMENTS: Buyer must notify Mutual of any shortages within five (5) days from the date the products were delivered to buyer. ICC regulations state that buyer is responsible for the following: (1) Inspecting shipment for lost or damaged merchandise, (2) Signing freight bill offered by the carrier as "short", "damaged", or "subject to further inspection", (3) Obtaining signature of the carrier acknowledging lost or damaged merchandise, (4) Notifying Freight Company of the claim and requesting an inspector. Mutual Industries is unable to handle a claim for you, since all damage claims must be adjusted at the delivery point per ICC regulations.



TO ORDER, CALL TOLL FREE: (800) 523-0888 or (215) 927-6000 115



707 W. Grange St.
Philadelphia, PA 19120

Tel: (215) 927-6000
Fax: (215) 927-3388
Call Toll Free (800) 523-0888

MUTUAL COMPANIES AND BRANDS FEATURED IN THIS CATALOG



SILTCO INDUSTRIES

MUTUAL'S MADE IN USA MANUFACTURING NOW SPANS ACROSS THE COUNTRY

Wherever there is a construction project you are likely to find a Mutual product. Mutual is continually expanding its manufacturing capabilities and product line to meet the ever changing needs of the construction industry.

Through the acquisition and creation of new companies and brands, Mutual has recently increased its Made in USA capabilities, adding 2 more plants — one in Huntington Beach, CA and the other in Pawtucket, RI. These bi-coastal locations allow Mutual to provide even more responsive on-time service, as well as cost savings on freight.

As a result, Mutual meets the needs of distributors by providing outstanding:

- Quality • Inventory • Service • Selection

Contact Mutual today and discover why so many distributors rely on Mutual for all their construction, safety, surveying, geotextile and erosion control needs.

CORPORATE HEADQUARTERS:

707 W. Grange St.
Philadelphia, PA 19120
Tel: (215) 927-6000
Fax: (215) 927-3388
Call Toll Free
(800) 523-0888
mutualindustries.com

MANUFACTURING LOCATIONS:

Philadelphia, PA • Baltimore, MD
Pawtucket, RI • Ft. Myers, FL
Huntington Beach, CA

STOCKING WAREHOUSES:

Philadelphia, PA • Baltimore, MD
Finksburg, MD • Pawtucket, RI
Ft. Myers, FL • Chicago, IL
Huntington Beach, CA
Sacramento, CA • Tacoma, WA

MUTUAL INDUSTRIES... Your One Great American Source



mutualindustries.com

